

# Analysis of the Problems Occurred Due To Partial Shading of Solar Photovoltaic Array and Probable Solutions

Arnaan Ronghangpi<sup>1</sup>, Jyoti Mahanta<sup>2</sup>, Joram Henjum<sup>3</sup>, Papul Changmai<sup>4</sup>

<sup>1,2,3,4</sup>Department of Electrical and Electronics Engineering, School of Technology, Assam Don Bosco University  
Airport Road, Azara, Guwahati-781017, Assam, INDIA

<sup>1</sup>arnaanronghangpi192621@gmail.com\*, <sup>2</sup>jyotimahanta.jm@gmail.com, <sup>3</sup>foxtailretusa17@gmail.com,  
<sup>4</sup>papul.changmai@dbuniversity.ac.in

**Abstract:** A solar panel is made up of solar cells where semiconductors made to react and give us a potential difference when solar energy falls on it. However, due to the internal and external interferences, many problems are faced by the solar panels like dust, partial shading by leaves or mud, etc. This paper aims at trying to find out the best possible solution for the partial shading problems when solar energy is harvested using a solar panel. The Series-Parallel configuration (SP) and the Total-Cross Tied configuration (TCT) connections of PV module have been analyzed using MATLAB.

**Keywords:** Partial shading; solar cells; solar energy; solar panels connections; MATLAB.

Open Access. Copyright ©Authors(s) and AJEEE. Distributed under the [Creative Commons Attribution 4.0 International License \(CC-BY\)](https://creativecommons.org/licenses/by/4.0/). Article history: Received: 1 Feb 2019 and Accepted: 15 March 2019.

## 1. Introduction

In the world today, conventional sources of energy faces the probability of dying off, leaving behind an extreme situation where we will not have any sources of energy if we do not come up with alternative ones. Therefore, looking into this matter, people have started coming up with various sources of energy. One such source is the solar energy, efficient and cheap harvesting of which is a major challenge around the world. Solar panel itself faces many problems. Apart from these, the external sources of problem like partial shading and dust also need to be considered. So, in order to understand and tackle such problems, we decided to take up the topic of analyzing and find a really good solution to overcome the problems.

Solar energy has been in use for a long time by human civilizations. But in the past few years, this energy is being used to generate electricity in a direct as well as in an indirect way. If we are to produce electricity directly from the sunrays, then we have to install panels called photovoltaic plates. An indirect way to produce electricity is by heating up the water or salt. The water is turned into steam and this helps in turning the turbines that are attached to the generators. The salt that is used for producing electricity is heated to an extremely high temperature. Then this is used to produce steam [4].

## 2. Partial Shading Problem

The photovoltaic (pv) plates that are used in the generation of electricity are made up of semiconductors. The semiconductor metal present in the cells has electrons and protons present. The electrons moves from one point to another creating a potential difference. This potential difference is what allows the pv plates to generate DC voltage and in turn, we can use the electricity produced for our own use.

But, the downside to a pv plate is that since it has electrons and protons, the possibility of reverse voltage occurring due to not getting enough light to excite the electrons is also high. So we need to take care of such a situation occurring. This type of situation is especially dangerous for the life of the pv plate if it is not corrected in time. A hotspot forms if the area covered is not uncovered in time. Also, the electrical production of the array is also affected to a large extent. To overcome this problem, we aim at coming up with a new algorithm that can decrease both the problems due to bad connection and the hotspots formed. The new connection will be increase the production efficiency of the solar pv panels and reduce the effect of partial shading in the pv panels.

The research work by Vaishnavi P. Deshpande and Sanjay B. Bodkhe [1] focuses on analyzing the outputs of different existing

connections of solar panels under different shading conditions. This paper gives an analysis of how under different shading conditions the module output is and how the output is entirely dependent on the connections done to the module to create an array. In another research H. Samet, S. Kolsi and M. Ben Amar [2] focuses on the irradiance and temperature parameters changes systematically during the day, so the MPP (Maximum Power Point) also changes. This paper gives us an analysis that along with this change if there is any change in the mechanics of the module due to PSC (Partial Shading Condition), the module also can get damaged.

### 3. Method

The algorithms for partial shading problem that are presently in use provide us not even half of the total power that can be harnessed from the solar rays that is we get. This also in turn gets reduced in half due to factors like shading connections that do not give good output, etc. We plan to come up with an algorithm that can be used to connect the panels in such a manner that we can increase the productivity of the panels to a much larger extent. We analyzed the connections that are in use so far and compared the results of all the new type of connections that we can make with these existing results and conclude a new connection that can give us a better result compared to the new one. MATLAB application has been used to simulate solar cells as well as solar panels to get various results that we compared it with the results of the existing connection models that have been recorded so far. The Series-Parallel configuration (SP) and the Total-Cross Tied configuration (TCT) connections of pv module have been analyzed using MATLAB.

### 4. Results and Analysis

The MATLAB simulation results of the various probable pv panel connections have been listed below.

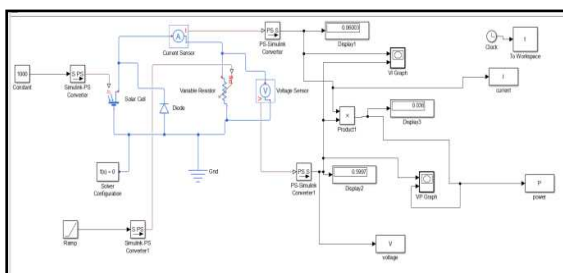

Figure 1: Circuit diagram of a solar cell

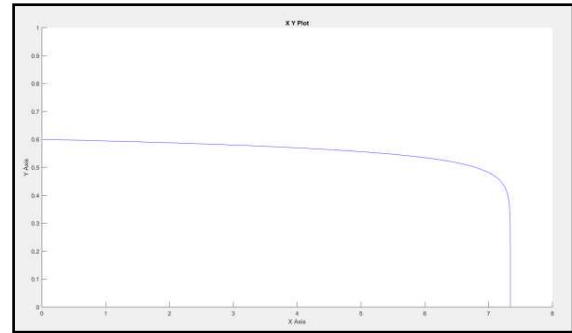

Figure 2: V-I characteristics of a solar cell

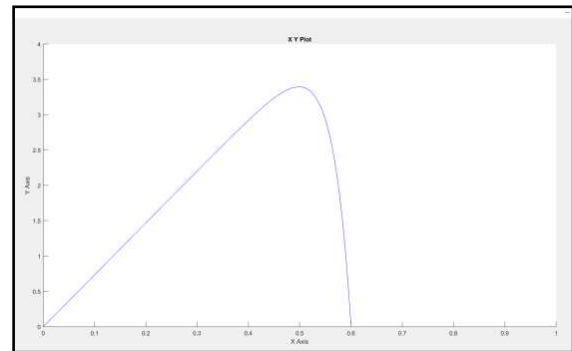

Figure 3: V-P characteristics of solar cell

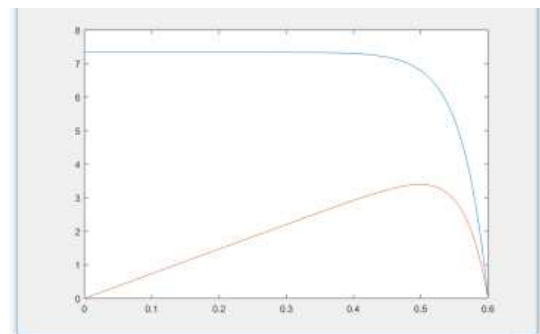

Figure 4: V-I, V-P characteristics of solar cell

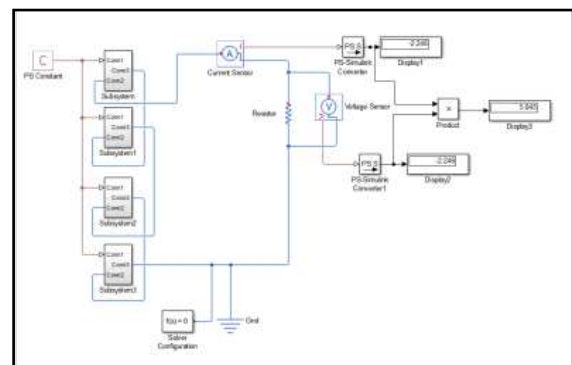

Figure 5: Series-Parallel connection

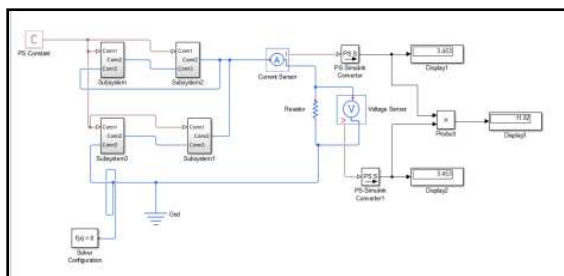

Figure 6: TCT connection

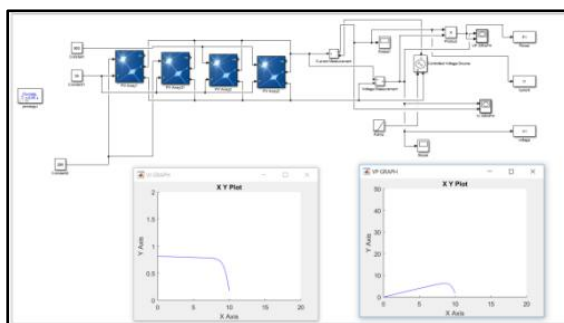

Figure 7: A TCT connection of pv panel along with its graph

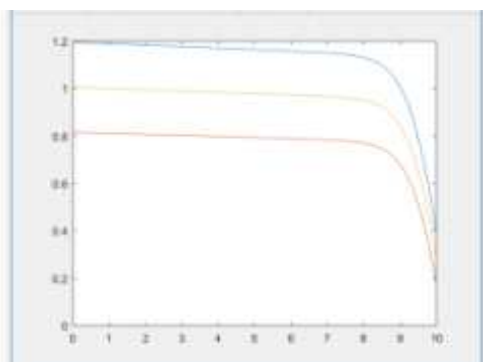

Figure 8: A V-I comparison between the different values obtained during different conditions

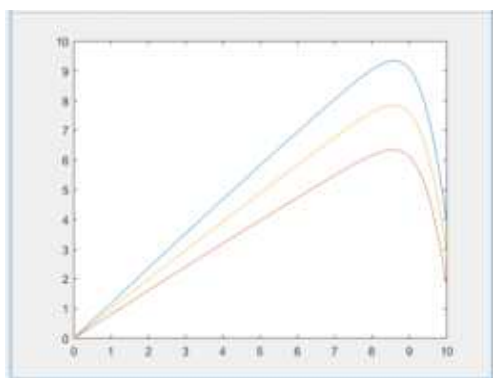

Figure 9: A V-P comparison between the different values obtained during different conditions

## 5. Conclusion and Future Prospects

We concluded the findings by doing various simulations for various connections and found that there is a huge difference between the result for a TCT connection and a series parallel connection.

To make a more reliable results for a better output, we can collect more raw data and try to make a model out of the connection we may consider as best so that a confirmed physical output can be made.

## References

- [1] V. P. Deshpande and S. B. Bodkhe, "Analysis of Various Connection Configuration of Photovoltaic Module under Different Shading Conditions", *International Journal of Applied Engineering Research*, Vol. 12, Issue 16, 2017, pp. 5715-5720. Retrieved from [https://www.ripublication.com/ijear17/ijear12n16\\_42.pdf](https://www.ripublication.com/ijear17/ijear12n16_42.pdf)
- [2] H. Samet, S. Kolsi and M. Ben Amar, "Design Analysis of Photovoltaic Generators Controlled by MPPT for Optimal Energy Transfer throughout a clear day", *Journal of Power and Energy Engineering*, Vol. 2, Issue 1, 2014, pp. 27-34. Doi: 10.4236/jpee.2014.21004
- [3] S. Sharma, K. K. Jain and A. Sharma, "Solar Cells: In Research and Applications- A Review", *Scientific Research*, Vol. 6, Issue 12, 2015, pp. 1145-1155. Doi: <http://dx.doi.org/10.4236/msa.2015.612113>
- [4] S. P. Sukhatme, *Solar Energy, Principles of Thermal collection and Storage*, 2nd edition, Tata McGraw-Hill Education, Delhi, 1996.
- [5] M. Boxwell, *Solar Electricity Handbook*, Greenstream Publishing, Kolkata, 2012.
- [6] C. Saravanan, M. A. Panneerselvam and I. W. Christopher, "A Novel Low Cost Automatic Solar Tracking System", *International Journal of Computer Applications*, Vol. 31, Issue 9, October 2011, pp. 62-67. Retrieved from <https://pdfs.semanticscholar.org/e69c/13d5f9d5c0ed75d066adf25d7962623c9b24.pdf>
- [7] E. F. A. Al-Showany, "The Impact of the Environmental Condition on the Performance of the Photovoltaic Cell", *American Journal of Energy Engineering*,

Vol. 4, Issue 1, pp. 1-7, 2016. Doi: 10.11648/j.ajee.2016401.11

- [8] D. S Rajput and K. Sundhakar, "Effect of Dust on the Performance of Solar PV Panel", *International Journal of ChemTech Research*, Vol. 5, Issue 2, 2013, pp. 1083-1086. Retrieved from [http://sphinxssai.com/2013/conf/PDFS%20ICGSEE%202013/CT=77\(1083-1086\)ICGSEE.pdf](http://sphinxssai.com/2013/conf/PDFS%20ICGSEE%202013/CT=77(1083-1086)ICGSEE.pdf)
- [9] S. Dubey, J. Narotam Sarvaiya and B. Seshadri, "Temperature Dependent PV Efficiency and its Effect on PV Production in the World- A Review", *Energy Procedia*, Vol. 33, 2013, pp. 311-321. Retrieved from <https://dio.org/10.1016/j.egypro.2013.05.072>
- [10] C. U. Ike, "The Effect of Temperature on the Performance of a PV Solar System in Eastern Nigeria", *International Journal of Engineering and Science*, Vol. 3, Issue 12, 2013, pp. 10-14. Retrieved from [researchinventy.com/papers/v3i12/C0312010014.pdf](http://researchinventy.com/papers/v3i12/C0312010014.pdf)

## Authors' Profiles

**Arnaan Ronghangpi**, currently pursuing Bachelor degree in Electrical and Electronics Engineering, final semester, Assam Don Bosco University (India).



**Jyoti Mahanta**, currently pursuing Bachelor degree in Electrical and Electronics Engineering, final semester, Assam Don Bosco University (India).



**Joram Henjum**, currently pursuing Bachelor degree in Electrical and Electronics Engineering, final semester, Assam Don Bosco University (India).



**Papul Changmai**, M.Tech., is working as an assistant professor in Assam Don Bosco University, India. He received his Bachelor degree in Electrical Engineering from Jorhat Engineering College (India) in 2008. He received his Master degree in Electronics and Communication Engineering from Assam Don Bosco University (India) in 2015. He is currently pursuing PhD in Electronics and Communication from NIT, Arunachal Pradesh (India). His areas of interest are Design of Solar Photovoltaic System and Partial Shading Analysis of Solar Photovoltaic Array.

