

DESIGN OF 28 GHZ MICROSTRIP MIMO ANTENNAS FOR FUTURE 5G APPLICATIONS

Yusnita Rahayu, Luthfi Afif, M.R Radhelan, I. Yasri, Feri Candra

Department of Electrical Engineering, Faculty of Engineering, Universitas Riau

Jl. HR. Subrantas KM. 12.5, Simpang Baru, Panam, Pekanbaru, Riau 28293

Email: yusnita.rahayu@lecturer.unri.ac.id, luthfi.afif@student.unri.ac.id,

muhammad.rizkiradhelan@student.unri.ac.id, indyasri@yahoo.com, fer_i@eng.unri.ac.id

Abstract – The 5G system requires more significant system capacity, more full bandwidth, and higher frequency. One type of antenna that can be used to increase the channel capacity is microstrip MIMO antenna. The Federal Communications Commission of the U.S. has recently designated the frequency band from 27.5 to 28.35 GHz for 5G applications. In this paper, the design of 28 GHz microstrip MIMO antenna for future 5G applications was proposed. The antenna was designed by using RT Duroid 5880 substrate with a dielectric constant of 2.2 and the loss tangent of 0.0009. The antenna operated from 27.10 GHz to 28.88 GHz with 1.78 GHz (6.35%) of bandwidth. The antenna consisted of four elements feeding by a microstrip line. Based on the simulated results, the high gain of 14.8 dBi is obtained with a linear directional pattern. Comparison performance regarding gain, return loss, VSWR and bandwidth are also presented for single, two and four elements. It is shown that the increasing number of elements of antenna increased the gain and the return loss. The antenna meets the 5G requirements.

Keywords: Antenna; Microstrip; MIMO; 5G Application;

Received: January 12, 2018

Revised: July 19, 2018

Accepted: July 25, 2018

INTRODUCTION

The 5G is going on and expected to be initiated by 2020 to provide extremely high data rate for multimedia applications and internet of things (IoT) (Wang et al., 2017). The 5G system requires bigger system capacity, wider bandwidth, and higher frequency (Chen et al., 2017).

There are two main directions of the development for 5G technologies: millimeter wave (mm) and MIMO (Tang et al., 2017). The MIMO with a large number of base station antennas on the transmitting and receiving ends can maximize the channel capacity for delivering high data (Wang et al., 2017).

As the mobile industry looks toward scaling up into the millimeter-wave spectrum, carriers are likely to use the 28, 38, and 73 GHz bands that will become available for future technologies (Yoon and Seo, 2017).

The Federal Communications Commission of the U.S. has recently (July 2016) designated the frequency band from 27.5 to 28.35 GHz for 5G applications (Lin et al., 2017). In 5G requirements, the antenna should at least have a gain of 12 dBi and bandwidth of more than 1 GHz (Saada et al., 2017).

One type of antenna that can be used to increase the channel capacity of MIMO is a microstrip antenna (Wesołowski, 2010).

Microstrip planar antennas are popularly used because it has many benefits such as low cost, low profile, ease fabrication, and compact (Rahayu et al., 2018a) (Rahayu and Pohan, 2018)

In this paper, 28 GHz MIMO antenna with four elements was designed and analyzed. The proposed antenna dimension 16x14mm, printed on RT Duroid 5880. Our previous work on dual band 28/38 GHz MIMO antenna for 5G application has been published (Rahayu et al., 2018b). This paper is part of our antenna research projects.

The structure of this paper as follows: section 1 presents the introduction and the motivation of the research. Then, it is followed by section 2 where the design methodology is presented. Last, section 3 is the comparison of performance in term of return loss, gain, VSWR between single and MIMO antenna.

METHOD

Single Element

The model of a microstrip antenna with T-junction as voltage divider is shown in Fig. 1. This antenna uses RT Duroid 5880 with a dielectric constant of 2.2. Dimensions antenna is 16x14mm ($W_{sub} \times L_{sub}$) with the thickness of 1.575mm and the loss tangent of 0.0009.

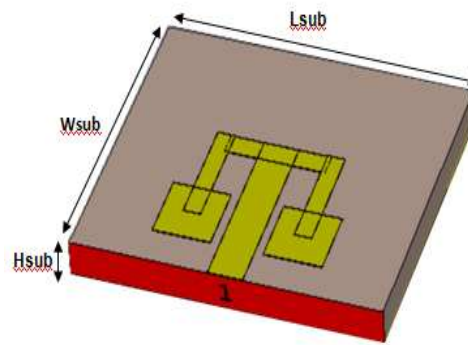

(a)

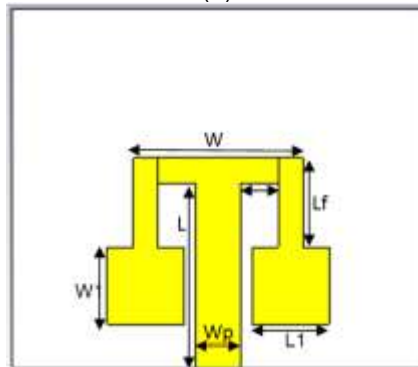

(b)

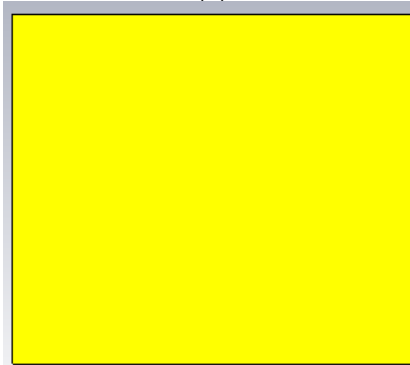

(c)

Figure 1. Geometry of antenna (a) 3D view, (b) top view, and (c) bottom view

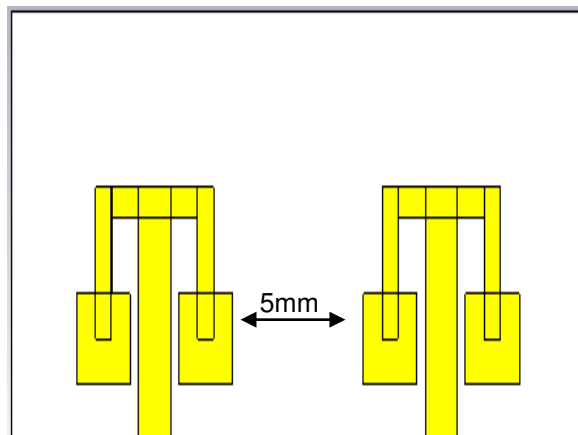

Figure 2. Two elements of an antenna

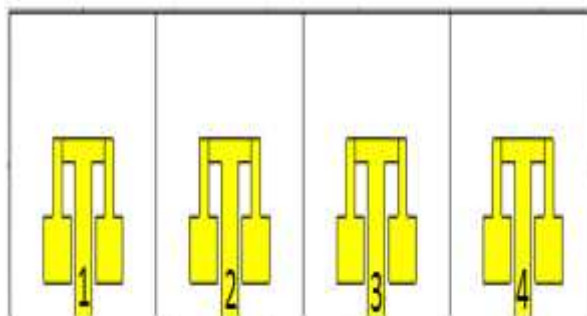

Figure 3. Four elements of an antenna

Two Elements of Antenna

The design of MIMO antenna with two elements is presented in Fig. 2. The distance between patches is determined by 5 mm.

Four Elements of Antenna

The proposed antenna is shown in Fig. 3. It consists of 4 ports microstrip feed line and four elements of MIMO antenna.

Microstrip feed line is placed on the bottom side of the substrate with 50 ohm impedance. A full ground plane is used. Table 1 shows the dimension of the single element.

Table 1. Single element parameter

Parameters	Value (mm)
W_{sub}	16
L_{sub}	14
H_{sub}	1.575
W	6.6
L	13
W_p	1.8
W_f	1.7
L_f	3.5
W_1	3
L_1	3

RESULTS AND DISCUSSION

Single Element

Fig. 4 shows the simulated reflection coefficient S_{11} of a single element at 28 GHz. It provides -46 dB at 28.015 GHz. It has approximately 1.91 GHz of bandwidth obtained.

Fig. 5 presents the radiation pattern and 3D surface current. As shown in Fig. 5(a), this antenna has a linear directional pattern with 6.76 dBi of gain. Fig. 5(b) shows the current distribution of the antenna, most of the currents flow is concentrated around the arm and on the feeder of this antenna.

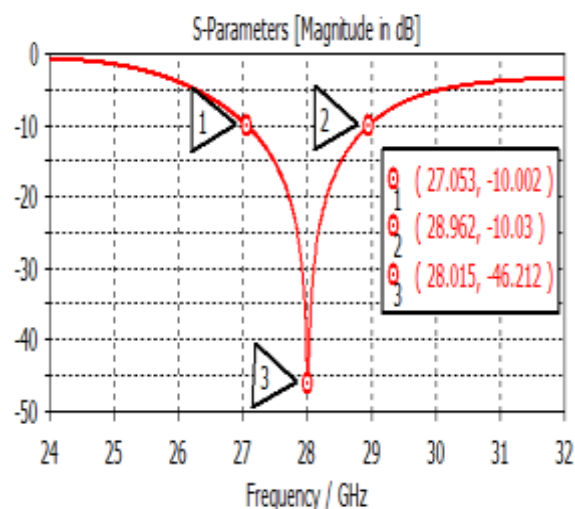
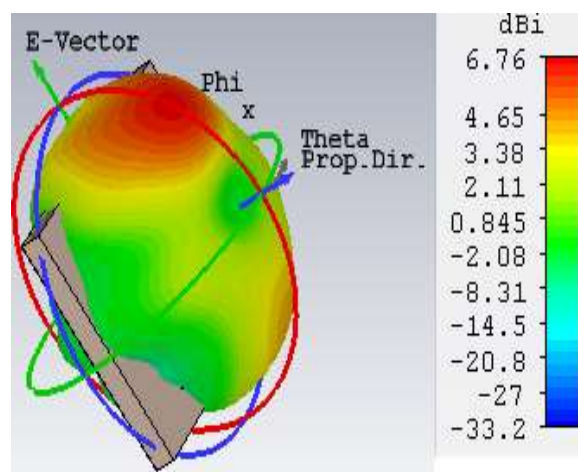

Figure 4. The simulated reflection coefficient of a single element



(a)

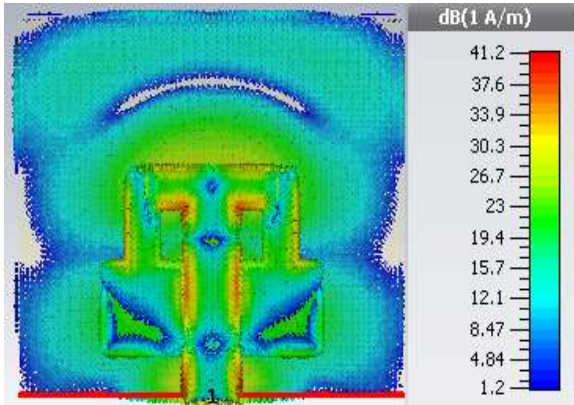

Figure 5. (a) Radiation pattern (b) Surface current of the single element

At 28 GHz, this antenna has a good efficiency with more than -0.0407 dB of radiation efficiency and -0.8812 dB of total efficiency. The simulated result of efficiency antenna is shown in Fig. 6.

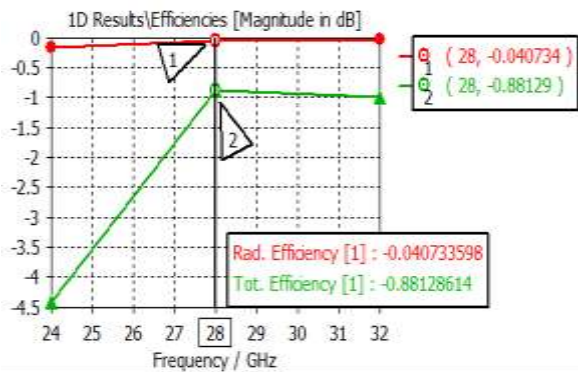

Figure 6. Radiation efficiency and total efficiency of the single element

Two Elements of Antenna

The MIMO antenna design will evaluate the effect of increasing the number of elements with the antenna's performance. The MIMO antenna design with two and four elements are created by using a single element of the antenna and use the same dimension as Fig. 1.

As shown in Fig. 7, the simulated reflection coefficient increased to -41 dB for two elements antenna compared to the reflection coefficient of a single element. Antenna with two elements has two ports that cause the mutual coupling between ports. From the simulation, the mutual coupling between each port is below -29 dB. The mutual coupling is represented with S-parameter (S_{12}). The bandwidth obtained is 1.82 GHz (6.5%) within 27.08-28.90 GHz.

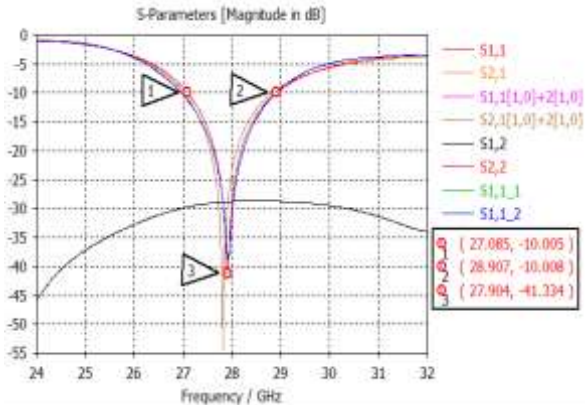

Figure 7. The reflection coefficient of two elements MIMO antenna

As shown in Fig. 8, the gain of antenna reaches 10.4 dBi with side lobe level obtained is -2.9 dB.

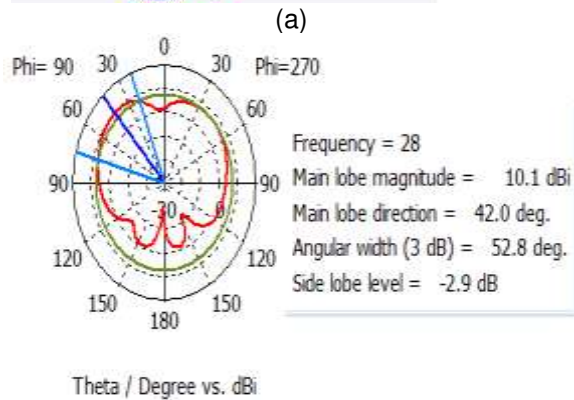
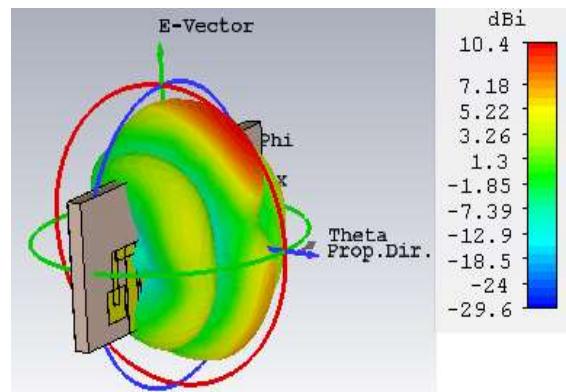

Figure 8. Radiation Pattern and Gain (a) 3D view and (b) Polar view

Four Elements of Antenna

The simulated S-parameter is illustrated in Fig. 9. The simulated reflection coefficient of four elements antenna is increased to -32 dB compared to single and two elements antenna. It is observed that the mutual coupling is below -29 dB. The bandwidth of 1.78 GHz (6.35%) within 27.10-28.88 GHz is obtained.

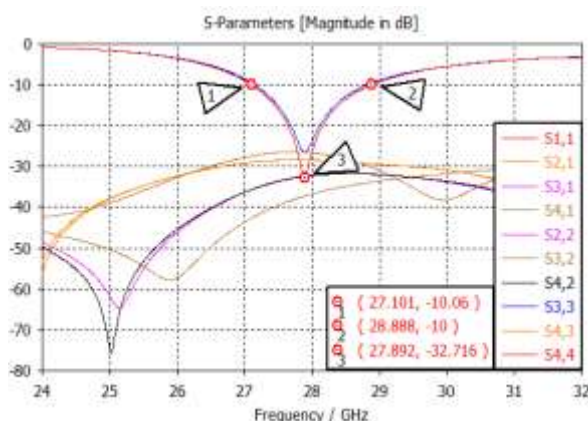
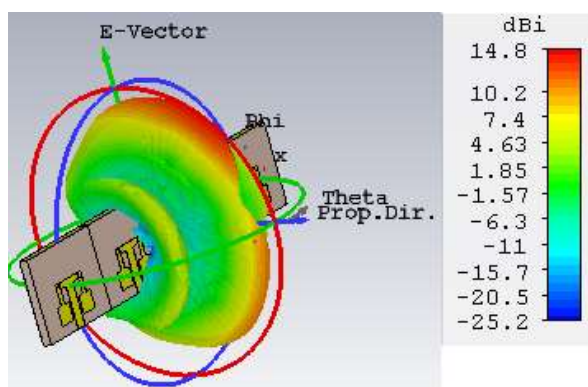

Figure 9. Simulated S-parameters of four elements of the antenna

The proposed antenna reaches a high gain of 14.8 dBi at 28 GHz. The side lobe is -3.6 dB with the main lobe direction of 51 deg. It shows the linear directional pattern as illustrated in Fig. 10.



(a)

Farfield (Array) Directivity Abs (Phi=90)

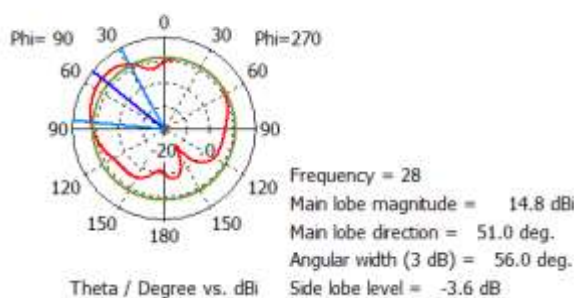

(b)

Figure 10. Radiation pattern and Gain
(a) 3D view (b) Polar view

Table 2. Comparison Performance in MIMO Antennas

Parameter	Gain (dB)	Bandwidth (GHz)	Return loss (dB)	VSWR
Single Element	6.76	1.91	-46	1.009
Two Element	10.4	1.82	-41	1.075
Four Element	14.8	1.78	-32	1.099

Table 2 lists the comparison regarding gain, bandwidth, return loss and VSWR for single, two and four elements antenna. It shows that the highest gain is obtained for the antenna with four elements. However, the highest bandwidth is obtained for a single element antenna. Antenna with four elements has the highest reflection coefficient; this is due to the mutual coupling between each port.

CONCLUSION

The design of four elements MIMO antenna has been proposed for future 5G applications. The working frequency is 27.10 GHz to 28.88 GHz with 1.78 GHz of bandwidth and VSWR is below 1.099. This antenna has the highest gain of 14.8 dBi with an acceptable sidelobe level of -3.6 dB. It is shown that the proposed antenna meets the 5G requirements.

ACKNOWLEDGEMENTS

The authors would like to thanks to Ministry of Research, Technology and Higher Education of the Republic of Indonesia for their research funding and Wireless Communication Centre (WCC), Universiti Teknologi Malaysia for their support and collaboration.

REFERENCES

- Chen, Y., Jian, R., Ma, S., & Mohadeskasaei, S. A. (2017). A research for millimeter wave patch antenna and array synthesis. In *26th Wireless and Optical Communication Conference (WOCC), NJ, USA*. 1-5. <http://dx.doi.org/10.1109/WOCC.2017.7929006>
- Lin, W., Ziolkowski, R. W., & Baum, T. C. (2017). 28 GHz Compact Omnidirectional Circularly Polarized Antenna for Device-to-Device Communications in the Future 5G Systems. *IEEE Transactions on Antennas and Propagation*. 65(12), 6904-6914. <http://dx.doi.org/10.1109/TAP.2017.2759899>
- Rahayu, Y. and Pohan, I. A. (2018). Design of Rectangular with 3 Slot Microstrip Antenna for Application LTE 2.1 GHz. *SINERGI*. 22(2),

- 127-131.
<http://dx.doi.org/10.22441/sinergi.2018.2.009>
- Rahayu, Y., Asrul, M. R., & Rahayu, T. (2018). Design MIMO 1x8 Antenna for Future 5G Applications. *TELKOMNIKA*. 16(2), 600-605.
<http://dx.doi.org/10.12928/telkomnika.v16i2.8383>
- Rahayu, Y., Fitria, L., Hakiki, Y., & Kurniawan, A. (2018). A new 2x 4 array design of dual-band millimeter-wave antenna for 5G applications. In *2018 International Workshop on Antenna Technology (iWAT)*. Nanjing, China. 1-4.
<http://dx.doi.org/10.1109/IWAT.2018.8379210>
- Saada, M. A., Skaik, T., & Alhalabi, R. (2017). Design of Efficient Microstrip Linear Antenna Array for 5G Communications Systems. In *2017 International Conference on Promising Electronic Technologies (ICPET)*. Deir El-Balah, Palestine. 43-47.
<http://dx.doi.org/10.1109/ICPET.2017.14>
- Tang, T., Wang, J. Y., & Deng, B. (2017). Hexagonal prism antenna for MIMO applications. *Microwave and Optical Technology Letters*. 59(11), 2752-2757.
<http://dx.doi.org/10.1002/mop.30808>
- Wang, J. Y., Tang, T., & Zhang, R. L. (2017). Multi-Band Omnidirectional Antenna with Hexagonal Prism Shape for MIMO Applications. *Progress In Electromagnetics Research C*, 75, 75-86.
- Wesołowski K. (2010). *Application of MIMO And Network Coding in Two-Way Relaying Applied In LTE*. *Proceeding of IEEE 21st International Symposium on Personal, Indoor and Mobile Radio Communications (PIMRC)*. Istanbul, Turkiye. 619-624.
<http://dx.doi.org/10.1109/PIMRC.2010.5671752>
- Yoon, N., & Seo, C. (2017). A 28-GHz Wideband 2x 2 U-Slot Patch Array Antenna. *Journal of Electromagnetic Engineering and Science*. 17(3), 133-137.
<http://dx.doi.org/10.5515/JKIEES.2017.17.3.133>