

INTERNATIONAL CONFERENCE



The Second International Conference on
Engineering and Technology Development

2nd ICETD 2013

27, 28, 29 August 2013, Bandar Lampung, Indonesia



PROCEEDINGS



In
Cooperations
With :



الجامعة الإسلامية العالمية
INTERNATIONAL ISLAMIC UNIVERSITY MALAYSIA
بوتنيونينى الشارقة انتار اقطرا ماليزيا



Hosted by :

Faculty of Engineering and Faculty of Computer Science,
Bandar Lampung University (UBL), Indonesia

2nd ICETD 2013

THE SECOND INTERNATIONAL CONFERENCE
ON ENGINEERING AND TECHNOLOGY DEVELOPMENT

28 -30 January 2013
Bandar Lampung University (UBL)
Lampung, Indonesia

PROCEEDINGS

Organized by:



Faculty of Computer Science and Faculty of Engineering
Bandar Lampung University (UBL)
Jl. Zainal Abidin Pagar Alam No.89 Labuhan Ratu, Bandar Lampung, Indonesia
Phone: +62 721 36 666 25, Fax: +62 721 701 467
website : www.ubl.ac.id

PREFACE

The Activities of the International Conference is in line and very appropriate with the vision and mission of Bandar Lampung University (UBL) to promote training and education as well as research in these areas.

On behalf of the Second International Conference on Engineering and Technology Development (2nd ICETD 2013) organizing committee, we are very pleased with the very good response especially from the keynote speaker and from the participans. It is noteworthy to point out that about 80 technical papers were received for this conference.

The participants of the conference come from many well known universities, among others : University Kebangsaan Malaysia – Malaysia, APTIKOM – Indonesia, Institut Teknologi sepuluh November – Indonesia, Surya Institute – Indonesia, International Islamic University – Malaysia, STMIK Mitra Lampung – lampung, Bandung Institut of Technology – Bandung, Lecture of The Malahayati University, B2TP – BPPT Researcher – lampung, Starch Technology Center – Lampung, Universitas Islam Indonesia – Indonesia, Politeknik Negeri Malang – Malang, University of Kitakyushu – Japan, Gadjah Mada University – Indonesia, Universitas Malahayati – Lampung, Lampung University – lampung, Starch Technology Center – Lampung, Universitas Riau – Riau, Hasanuddin University – Indonesia, Diponegoro University – Indonesia, King Abdulaziz University – Saudi Arabia, Parahyangan Catholic University – Indonesia , National Taiwan University–Taiwan, Surakarta Christian University – Indonesia, Sugijapranata Catholic University – Indonesia, Semarang University – Indonesia, University of Brawijaya – Indonesia, PPKIA Tarakanita Rahmawati – Indonesia, Kyushu University, Fukuoka – Japan, Science and Technology Beijing – China, Institut Teknologi Sepuluh Nopember – Surabaya, Researcher of Starch Technology Center, Universitas Muhammadiyah Metro – Metro, National University of Malaysia – Malaysia.

I would like to express my deepest gratitude to the International Advisory Board members, sponsor and also to all keynote speakers and all participants. I am also gratefull to all organizing committee and all of the reviewers who contribute to the high standard of the conference. Also I would like to express my deepest gratitude to the Rector of Bandar Lampung University (UBL) who give us endless support to these activities, so that the conference can be administrated on time

Bandar Lampung, 29 August 2013-08-26

Mustofa Usman, Ph.D
2nd ICETD Chairman

PROCEEDINGS

2nd ICETD 2013

The Second International Conference
On Engineering And Technology Development

28 -30 January 2013

INTERNATIONAL ADVISORY BOARD

Y. M Barusman, Indonesia
Ahmad F. Ismail, Malaysia
Mustofa Usman, Indonesia
Moses L. Singgih, Indonesia
Andreas Dress, Germany
Faiz A.M Elfaki, Malaysia
Warsono, Indonesia
Raihan Othman, Malaysia
Zeng Bing Zen, China
Tjin Swee Chuan, Singapore
Khomsahrial R, Indonesia
Rony Purba, Indonesia
Alex Tribuana S, Indonesia
Hon Wei Leong, Singapore
Imad Khamis, USA
Rozlan Alias, Malaysia
Rudi Irawan, Indonesia
Gusri Ibrahim, Indonesia
Jamal I Daoud, Malaysia
Riza Muhida, Indonesia
Heri Riyanto, Indonesia
Agus Wahyudi, Indonesia
Lilies Widojoko, Indonesia

PROCEEDINGS

2nd ICETD 2013

The Second International Conference
On Engineering And Technology Development

28 -30 January 2013

STEERING COMMITTEE

Executive Advisors

Dr. M. Yusuf S. Barusman
Andala R. P. Barusman, MA.Ec

Chairman

Mustofa Usman, Ph.D

Co-Chairman

Dr. Ir. Hery Riyanto, MT
Ahmad Cucus, S.Kom., M.Kom

Secretary

Marzuki, S.Kom., M.Kom
Maria Shusanti Febrianti, S.Kom., M.Kom

Technical Committee

Indyah Kumoro, ST. IAI
Ardiansyah, ST., MT
Sofiah Islamiah, ST. MT
Taqwan Thamrin, ST., MSc
Dina Ika Wahyuningsih, S.Kom
Agus Sukoco, M.Kom
Hj. Susilowati, ST. MT
Haris Murwadi, ST, MT
Robby Yuli Endra, S.Kom., M.Kom
Fenty Ariani, S.Kom., M.Kom

Treasure

Samsul Bahri, SE
Dian Agustina, SE

PROCEEDINGS

2nd ICETD 2013

The Second International Conference
On Engineering And Technology Development

28 -30 January 2013

ORGANIZING COMMITTEE

Chair Person

Dr. Ir. Hery Riyanto, MT

Vice Chair Person

Yuthsi Aprilinda, S.Kom., M.Kom

Treasure

Dian Agustina, S.E

Secretary

Aprizal, ST. MT

Ir. Tjejeng Sofyan, MM

Ir. Muhammad Zein, MT

Ir. Bambang Pratowo, MT

Special Events

Ir. Juniardi, MT

Ir. Indra Surya, MT

Ir. Sugito, MT

DR. Baginda Simaibang, M.Ed

Berry Salatar, S.Pd

Yanuar Dwi Prasetyo, S.Pd.I., M.A

Receptionist

Ir. Najamudin, MT

Kunarto, ST. MT

IB. Ilham Malik, ST. MT

Ir.A Ikhsan Karim, MT

Ir. Asikin, MT

Usman Rizal, ST., M.MSi

Transportation and Acomodation

Irawati, SE

Desi Puspita Sari, S.E

Tanto Lailam, S.H

Ilyas Sadad, S.T., M.T

Publication and Documentation

Ir. Indriati Agustina Gultom, M.M

Noning Verawati, S.Sos

Hesti, S.H

Rifandi Ritonga, SH

Violita, S.I.Kom

Cosumption

Dra. Yulfriwini, M.T

Wiwin Susanty, S.Kom., M.Kom

Fenty Ariani, S.Kom., M.Kom

Reni Nursyanti, S.Kom., M.Kom

Erlangga, S.Kom

Arnes Yuli Vandika, S.Kom

Facility and Decoration

Siti Rahma Wati, SE

Dina Ika Wahyuningsih, S.Kom

Zainal Abidin, SE

Ahyar Saleh, SE

Eko Suhardiyanto

Wagino

Sugimin

Table Of Content

Organizing Committee	i
Table Of Content.....	v
Keynote Speaker	
1. Recent Advances in Biofuel Cell and Emerging Hybrid System Abdul Aziz Ahmad and Raihan Othman	1
2. Waste Utilization Study Tailing Gold Mine in Way Linggo-Lampung, as Fine Aggregate Materials for Producing Mortar Materials based on concept of Green Technology Lilies Widodojoko & Susilawati	8
3. Infrastructure Health Monitoring System (SHM) Development, a Necessity for Maintance and Investigation Prof. Dr. Priyo Suprobo, Faimun, Arie Febry	17
4. Four Phases Quality Function Deployment (Qfd) By Considering Kano Concept, Time And Manufacturing Cost Prof. Dr. Moses L Singgih, Dyah L. Trenggonowati, Putu D. Karningsih	22

Speaker

1. Comparative Analysis for The Multi Period Degree Minimum Spanning Tree Problem
Wamiliana, Amanto, and Mustofa Usman..... 39
2. Choosing The Right Software In Supporting The Successful of Enterprise ERP Implementation
Yodhie Yuniarthe, Idris Asmuni..... 44
3. Climate Adaptive Technology In Maintaining Vernacularism Of Urban Kampong Case study: Kampung Adat (Indiginous) Mahmud, Bandung District, West Java
Marcus Gartiwa..... 50
4. The Prospect Of Diesohol In Facing Fossil Fuel Crissis
M.C. Tri Atmodjo..... 63
5. The Potential Of Agriculture And Forestry Biomass Wastes As Source Of Bioenergy
Hardoyo..... 66
6. The Importance of Education Facility as Sustainable Urban Generation Tool
Fritz Akhmad Nuzir, Haris Murwadi and Bart Julien Dewancker 71
7. The implementation of Secton Method for Solving Systems of Non Linear Equations
Nur Rokhman 80
8. Quality Control Analysis Into Decrease The Level Defects On Coffee Product
Heri Wibowo, Sulastri and Emy Khikmawati 85
9. Public Transpotion Crisis In Bandar Lampung
Ida Bagus Ilham Malik 89
10. Geospatial Analysis of Land Use Change in Way Kuripan Watershed, Bandar Lampung City
Candra Hakim Van Rafi'1., Dyah Indriana Kusumastuti2., Dwi Jokowinarno..... 99
11. Material Utilization Technology Of Agriculture And Forestry Waste
Hardoyo..... 105
12. The Supply Chain System Of Cassava On The Tapioca Industry
Hardoyo..... 108
13. Glass Technology In Natural Light Glasses On Aperture Element In The Architecture World
Muhammad Rija & MT Pedia Aldy 113

14. An Eksperimental Permeable Asphalt Pavement Using Local Material Domato Stone On Quality Of Porous Asphalt Firdaus Chairuddin, Wihardi Tjaronge, Muhammad Ramli, Johannes Patanduk	117
15. Coordination Of Architectural Concepts And Construction Systems Eddy Hermanto.	129
16. Seismic Assessment of RC Building Using Pushover Analysis Riza Ainul Hakim.	136
17. Viscosity and Liquidity Index Relation for Elucidating Mudflow Behavior Budijanto Widjaja and Shannon Hsien-Heng Lee.	143
18. The Use of Pozzolanic Material for Improving Quality of Strontium Liquid Waste Cementation in Saline Environment during Nuclear Waste Immobilization Process Muhammad Yusuf, HayuTyasUtami, Tri SulistiyoHariNugroho, SusetyoHarioPutero	148
19. Geospatial Analysis Of Land Use And Land Cover Changes For Discharge At Way Kualagaruntang Watershed In Bandar Lampung Fieni Yuniarti, Dyah Indriana K, Dwi Joko Winarno.	153
20. Wifi Network Design For High Performance Heru Nurwarsito, , KasyfulAmron,BektiWidyaningsih	161
21. Studi on The Efficiency Using Nature Materials in The Structural Elements of Reinforced Concrete Beam Yasser , Herman Parung , M. Wihardi Tjaronge, Rudy Djamaluddin.	167
22. The Research Of Slow Release Nitrogen Fertilizer Applied In Sugarcane (Saccharum Officinarum) For Green Energy Bioethanol M.C. Tri Atmodjo, Agus Eko T. Nurul Rusdi, Sigit Setiadi, and Rina.	179
23. Energy Utilization Technology Of Agriculture And Forestry Waste Hardoyo.	185
24. Implementation Of Fuzzy Inference System With Tsukamoto Method For Study Programme Selection Fenty Ariani and Robby Yuli Endra.	189
25. The Analysis of Video Conference With ITU Standarization (International Telecommunication Union) That Joining in Inherent At Bandar Lampung University Maria Shusanti F, Happy Reksa	201

26. The E-internal audit iso 9001:2008 based on accreditation form assessment matrix in study program for effectiveness of monitoring accreditation
Marzuki, Maria Shusanti F...... 207
27. The Developing Of e-Consultations For Effectiveness of Mentoring Academy
Ahmad Cucus, Endang K 214
28. The Evaluation of information system performance in higher education case study with EUCS model at bandar lampung university
Reni Nursyanti, Erlangga...... 221
29. The Analysis Of History Collection System Based On AndroidSmartphone With Qr Code Using Qr CodeCase Study: Museum Lampung
Usman Rizal, Wiwin Susanty, Sutrisno...... 230
30. Application of Complaint Handling by Approach Model of ISO 10002 : 2004 to Increase Complaint Services
Agus Sukoco and Yuthsi Aprilinda. 235
31. Towards Indonesian Cloud Campus
Taqwan Thamrin, Iing Lukman, Dina Ika Wahyuningsih 252
32. Bridging Router to ADSL Modem for Stability Network Connection
Arnes Yuli Vandika and Ruri Koesliandana...... 257
33. The Effect of Use Styrofoam for Flexural Characteristics of Reinforced Concrete Beams
Yasser , Herman Parung, M. Wihardi Tjaronge, Rudy Djamaluddin 261
34. The Estimation Of Bioethanol Yield From Some Cassava Variety
M.C. Tri Atmodjo..... 273
35. Effect of Superficial Velocity of Pressure Difference on The Separation of Oil And Water by Using The T-Pipe Junctionl
Kms. Ridhuan and Indarto...... 277
36. The use of CRM for Customer Management at Cellular Telecommunications Industry
Ayu Kartika Puspa...... 293
37. Indonesian Puslit (Centre Of IT Solution) Website Analysis Using Webqual For Measuring Website Quality
Maria Shusanti Febrianti and Nurhayati. 297
38. The E-internal audit iso 9001:2008 based on accreditation form assessment matrix in study program for effectiveness of monitoring accreditation
Marzuki, Maria Shusanti F...... 307

39. Enhancing Quality Software Through CMMI-ISO 9001:2008 and ISO 9126 Agus Sukoco	320
40. Value Analysis Of Passenger Car Equivalent Motorcycle (Case Study Kartini Road Bandar Lampung) Juniardi, Aflah Efendi	337
41. Alternative Analysis Of Flood Control Downstream Of Way Sekampung River Sugito, Maulana Febramsyah.	347
42. Analysis Of Fitness Facilities And Effective Use Of Crossing Road Juniardi, Edi Haryanto.	353
43. Study On Regional Development Work Environment Panjang Port Lands In Support Bandar Lampung City As A Service And Trade Ir. A. Karim Iksan, MT, Yohn Ferry.	359
44. Analytical And Experimental Study Bamboo Beam Concrete Hery Riyanto, Sugito, Juli	370
45. Comparative Analysis Of Load Factor Method Static And Dynamic Method (Case Study Akdp Bus Route Rajabasa - Bakauheni) A. Ikhsan Karim, MT., Ahmad Zulkily.	378
46. Optimization Utilization Of Water Resources dam Batutegei Using Method Of Linear Program Aprizal, Hery Fitriyansyah	386
47. Characteristics Generation Traffic Patterns And Movement In Residential Area (Case Study Way Kandis Residential Bandar Lampung) Fery Hendi Jaya, Juniardi,	392
48. Use Study On Slight Beam Reinforced Concrete Floor Plate in Lieu Of Secondary Beam Hery Riyanto, Sugito, Lilies Widodjoko, Sjamsu Iskandar	399
49. Observation Of The Effect Of Static Magnetic Field 0.1 Mt On A-Amylase Activity In Legume Germination Rochmah Agustrina, Tundjung T. Handayani, and Sumardi.	405
50. Effectiveness Analysis Of Applications Netsupport School 10 Based Iso / Iec 9126-4 Metrics Effectiveness Ahmad Cucus, Nelcy Novelia	413
51. Comparative Performance Analysis Of Banking For Implementing Internet Banking Reza Kurniawan	418

Effect of Superficial Velocity of Pressure Difference on The Separation of Oil And Water by Using The T-Pipe Junction

¹Kms. Ridhuanand ²Indarto

¹Jurusan Teknik Mesin Universitas Muhammadiyah Metro
Jl. Ki Hajar Dewantara No. 116 Metro Timur Kota Metro -HP 085366311404

²Jurusan Teknik Mesin dan Industri, Universitas Gajah Mada Yogyakarta
Jl. Grafika No. 2 Yogyakarta Indonesia

Email : kmsridhuan@yahoo.co.id

Email : Indarto@ugm.ac.id

Abstract: *Many ways that is done to separate a mixture such as kerosene-water, such as by using branching pipes (T junction), the construction of the pipeline is composed of one side of the inlet, the run up (straight) and sidearm (upwards). This research aims to determine the effect of superficial velocity of mixture flow pressure difference at the T-junction that occurs on a kerosene-water separation efficiency. Research conducted by using a test section of the T-Junction with a 30 ° slope angle and radius bend 25 mm. pipe Material with a diameter of 1.5 inch Fleksiglass. Media used kerosene and water. The variables measured, namely that of kerosene and discharge water out through the side arm and run arm based on superficial velocity of kerosene and water according the test matrices. The difference in pressure at the T-Junction. Overall results of nicest phase separation occurs at 58% water cut, $J_{mix} = 0.36$ m/s downstream flow barriers, with 40% in 550,7 Pa pressure resulted in $F_k = F_w = 97\%$ and 2% that flows to the side arm, and $F_k = F_w = 3\%$ and 98% of that flows to run arm. The smaller the value of water cut the better efficiency of separation is achieved. The increasing speed of the shear stress of kerosene and superficial result in increasing pressure fluctuations. Also increased pressure downstream barriers. On J_{mix} 0.36 m/s is highest pressure 1400 Pa, on PSD signal fluctuations of 8000. With the increasing speed of superficial kerosene PSD magnitude decreased, and the strength of the apex of the PSD increased. On a superficial water medium speed with increasing speed of superficial water and kerosene for constant pressure difference loss occurring on the area of the inlet and run T-junction*

Keywords: *speed, pressure, kerosene-Water, T-junction.*

INTRODUCTION

Proese processing and production of the oil field in the world industry applications, such as in the oil processing industry. Where in the process of drilling the material contained in crude oil (crude oil) is made up of a mixture of water, gas and oil. These components need to be separated through a process of separation thus generated a net oil which is then forwarded to the storage tank. These constraints continue to do ongoing efforts for mengatsinya, one of which is the construction of the piping system installation T-Junction on the flow distribution channel to replace the function of the separator.

When the flow of two phase flow through a T-junction uneven distribution occurs on the quality of the mixture on both sides of the exit (run and side arm) from T-junction. The uneven distribution of the fluid flow impact on other parameters such as flow pattern and pressure gradient/decreasing the pressure on the inlet side to run (P12) and the inlet side to side arm (P13) (Gunawan, 2009).

Research on pressure changes in the pipe T-junction with fluid water – kerosene has not been much research done as T-junction with fluid water – air. Research of flow characteristic of the phase 2 through T-junction is mainly concentrated on phase distribution and pressure drop. Angeli and Hewitt (1998) examined the effect of volume fraction of water (water cut) and speed of superficial the mixture against the pressure gradient (pressure gradient) on a horizontal pipe with internal diameter of 1 inch to stainless steel pipes and pipe acrylic. Mixed speed used between 0,3 m/s – 3,9 m/s. the density of oil at temperature 20 °C 801 kg/m³ viscosity mPas, 1.6. From these experiments are obtained on the condition that a mixture with constant velocity water cut, pressure gradient on the stainless steel pipe is higher than acrylic pipes, this is due to the stainless steel pipe roughness factor greater than acrylic pipe.

Lovick and Angeli (2003) conducted a study concerning the pressure gradient to volume fractions of oil mixed with speed variation, at pipa horizontal stainless steel with inner diameter of 38 mm and as a working fluid is water and oil (viscosity 6 mPas and the density of 820 kg/m³). Experiment results show that with increasing percentage of volume fraction of oil pressure gradient then tends to diminish. Very small pressure gradient changes with the rise in the volume of oil fractions. Mix on speed 1 m/s – 3 m/s occur reduction of pressure gradient which tend to be large because of the addition of a volume of water into the oil flow is continuous.

Rodriguez et al (2005) examines the pressure gradient in horizontal pipe with fluid-mineral oil brine on the stainless steel pipe diameter 3-in, roughness 4.5 x 10⁻⁵ m with properties of mineral oil (830 kg/m³ density and viscosity of 7.5 mPas) and brine (1060 kg/m³ density and viscosity mPas 0,8). Pressure gradient was measured with the superficial velocity variation of brine (U_{ws}) and superficial velocity of mineral oil (U_{os}) constant i.e. 0.02 m/s, 0.07 m/s, 0,3 m/s, 0.6 m/s, 1.5 m/s and 3.0 m/s

superficial Velocity :superficial Velocity (J) (m/s) is defined as the ratio of the volumetric flow rate of a single phase (V) with broad transverse pipe (A). Here are some equations to determine the karakteristik of kerosene-water separation: (Yang L Azzopardi, b. j., 2006)

superficial Speed:

$$J_{ks} = \frac{A_k J_k}{A} \quad (1)$$

kecepatansuperficial Water :

$$J_{ws} = \frac{A_w J_w}{A} \quad (2)$$

Kecepatan *superficial* campuran :

$$J_m = J_{ks} + J_{ws} \quad (3)$$

$$\left(\frac{dP}{dx}\right)_t = \left(\frac{dP}{dx}\right)_f + \left(\frac{dP}{dx}\right)_g + \left(\frac{dP}{dx}\right)_a \quad (6)$$

Water volume fraction (*water cut*) :

$$\varepsilon_w = \frac{J_{ws}}{J_{ks} + J_{ws}} \quad (4)$$

Fraksi volumekerosene(*kerosene cut*) :

$$\varepsilon_k = \frac{J_{ks}}{J_{ks} + J_{ws}} \quad (5)$$

Two phase Flow pressure drop:Of two-phase flow, pressure drop (changes in fluid pressure that occurs because of two phase flow through a system) is an important parameter in the design. There is no general correlation for two phase flow pressure drop that is accurate, probably because the correlation is used to represent different physical situations. However, to determine the pressure drop is held such an approach considered homogeneous flow or separately.

to determine the pressure gradient on a liquid-liquid flow held approach with the flow are considered homogeneous or separately. The flow is considered to be homogeneous when both phases are mixed in with the good, while the flow is considered separately if the phase-phase flows physically separated with different speed (Koestoer et al, 1994). Pressure drop in two-phase flow is pressure from each phase are determined empirically. The variables that influence it is the frictional pressure gradient, gravity and Acceleration, which can be formulated as follows:

Pressure gradient due to the change of speed on the connection T-Junction determined by the equation proposed by (w. Seeger and j. Reimann, 1985), namely:

$$\left(\frac{dP}{dx}\right)_a = \frac{1}{2} K_{12} \left(\frac{G_2^2}{\rho_{m2}} - \frac{G_1^2}{\rho_{m1}} \right) \quad (7)$$

$$\rho_{m1} = \left(\frac{x_1^2}{\varepsilon_o \rho_o} + \frac{(1-x_1)^2}{\varepsilon_w \rho_w} \right)^{-1} \quad (8)$$

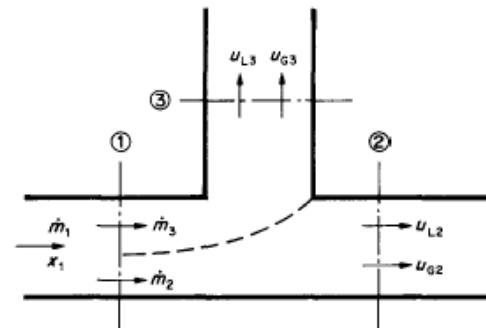

Figure 1. Fluid flow through a T-junction

In Figure 1, it appears that the flow rate on the side i.e. 1 point entrance (inlet), then head to the inflow branches (T Junction), a part of the flow towards the channel on point 2 (branch) and partly to flow straight to the point 3 (run). In this section some separate streams, some are up and there are continuing straight.

RESEARCH METHODS

The research of using kerosene fluid (density = 808 kg/m^3 and viscosity = $0,00192 \text{ kinematik kg/m.s}$) and water (density = 998 kg/m^3 and absolute viscosity = $0,00102 \text{ kg/m.s}$). Transparent test pipes with a diameter of akrilyc material in the 1.5 inch. T-junction angles used are 30 with nice bends with a radius of 25 mm.

In the early stages, the first water tank dipompakan from shelter into the pipeline until it

is full, the next of kerosene from the tank dipompakan the shelter into the pipeline so that kerosene and water will mix in a mixer. Once the kerosene and water are mixed in the mixer, then the flow rate are both governed by using valves and measured with flow meter with a value magnitudes correspond to the matrix of research tests in table 1. The flow of the mixture then flows into the test section and the magnitude of the mass fraction of a mixture out of both outlets are measured. Measurements of the flow pattern is done by using a camera on the side inlet and side of the T-Junction. Furthermore the flow out of both parts are dominant to run water and kerosene to the branch. Furthermore the flow into sparator, then separated, after which the water back into the reservoir tank of the water and kerosenepun so. Then in the same way do the measurements for.

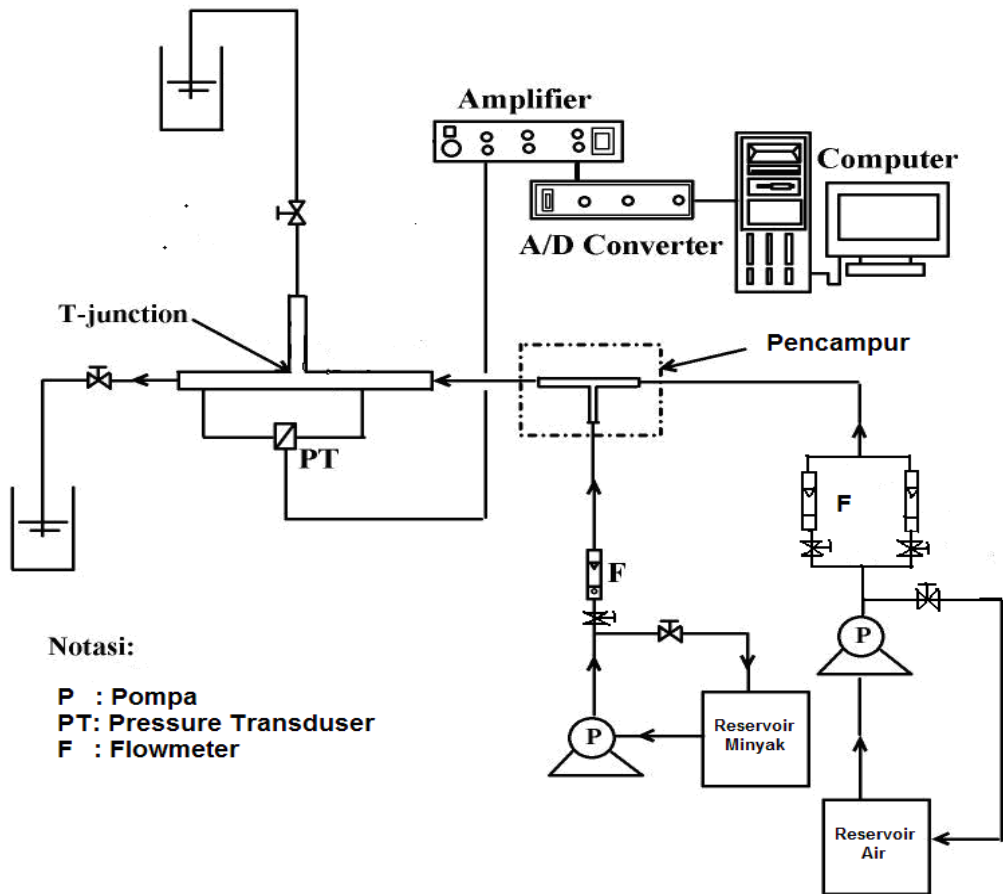

Figure 2. Pipe installation scheme flow test equipment

Table 1. Research test matrix

No.	Kecepatan <i>superficial</i> air J_w (m/s)	Kecepatan <i>superficial</i> kerosene J_k (m/s)
1	0,10	0,10
2	0,15	0,12
3	0,20	0,14
4	0,25	0,16
5	0,30	0,18
6	0,35	0,20

7	0,40	0,22
---	------	------

RESULTS AND DISCUSSION

Research Conditions: In this study used T-junction angle is 30°, done with three variations of downstream flow resistance; pressure on the downstream $Pd_1 = 550.7$ Pa, the pressure $Pd_2 = 1559.8$ Pa, and the pressure $Pd_3 = 2018.3$ Pa. Working fluid used was kerosene and water. Measurements were performed by 49 data for each setting downstream flow resistance, with the magnitude of water superficial velocity (J_w) and speed.

superficial kerosene (J_k) that are drawn in the test section is set using a flowmeter. J_k value range = 0.10 m / s - 0.22 m / s and $J_w = 0.10$ m / s - 0.40 m / s are made in the form of research test matrix as shown in Table 1. If seen from the magnitude of the volume fraction of water (water cut) flowing in the pipe, the measurement is started from $\varepsilon_w = 31\%$ - 80% and the mixture superficial velocity was varied in the range of values $J_{mix} = 0.20$ m/s - 0.62 m/s . The measured variable is the flow rate out of the side arm and arm run, the pressure difference between the inlet and run arm (ΔP_{1-2}) as well as between the inlet and the side arm (ΔP_{1-3}) using a differential pressure transducer (DPT) which is coupled with other instruments the regulator and a digital oscilloscope (DSO) which is connected to a set of computer that is used to process the data. To measure the flow at the downstream side used of the manometer-U.

Results of Phase Separation: Data results are presented based on the comparison of phase separation and kerosene fractions fraction water flowing into the side arm on the condition of water cut 58%, 64% and 71%, also on condition of downstream flow resistance pressure of 550.7 Pa;

1559.8 Pa and 2018, 3 Pa. Graph of phase separation occurring in the T-junction.

Table 2. Data phase separation with water cut 58 %

Jw (m/s)	Jk (m/s)	Jmi x (m/s)	Fk	Fw	P downstream (Pa)
0.20	0.14	0.34	0.93	0.02	550,7
0.20	0.14	0.34	0.93	0.82	1559,8
0.20	0.14	0.34	0.90	0.42	2018,3
0.20	0.16	0.36	0.89	0.04	550,7
0.20	0.16	0.36	0.91	0.91	1559,8
0.20	0.16	0.36	0.86	0.47	2018,3
0.25	0.18	0.43	0.90	0.12	550,7
0.25	0.18	0.43	0.96	0.85	1559,8
0.25	0.18	0.43	0.91	0.48	2018,3
0.30	0.22	0.52	0.87	0.21	550,7
0.30	0.22	0.52	0.94	0.88	1559,8
0.40	0.22	0.52	0.88	0.63	2018,3

Phase separation results are shown by Table 3. Good separation occurs at 58% water cut, $J_{mix} = 0.36$ m/s or ($J_w = 0.20$ m/s and $J_k = 0.16$ m/s) and at a pressure of 550.7 Pa downstream barriers. Where 97% kerosene fraction flowing into side arm and 2% fraction of water flowing to the side arm, it means to run arm $F_k = 3\%$, F_w to run arm = 98%, data on water cut 58% complete can be seen in table 2 above.

Table 3. Highest value on the separation efficiency of the bend angle T-junction

$\epsilon_w = 58\%$			$\epsilon_w = 64\%$			$\epsilon_w = 71\%$		
Fm	x1	H (%)	Fm	x1	H (%)	Fm	x1	H (%)
0,38	0,33	97	0,33	0,33	99	0,43	0,51	85
8	9		8	8		3	1	

Separation Efficiency Results: To identify the optimal conditions for phase separation, the separation of the data plotted by comparison of the phase separation efficiency (η) and integral mass fraction (F_m). Efficiency of phase separation that occurs with a peak efficiency of 97%, which is integral to a mass fraction of 0.38 and kerosene at the inlet quality of 0.38. This condition occurs in 58% water cut, $J_{mix} = 0.32$ m/s or ($J_w = 0.20$ m/s and $J_k = 0.12$ m/s) and a pressure of 550.7 Pa downstream barriers. For all the superficial velocity of water cut and mix the same approach ($J_{mix} = 0.32$ m/s - 0.35 m/s) indicate that close to peak efficiency at around 96% - 98%, occurred in the setting of 550.7 Pa downstream.

If the data points are on the line separating the first mixture of kerosene and water flowing to run arm while the second separation line means pure water flow to run arm. This is because the effect of the bend angle is the smaller angle bends the centrifugal force of the phase kerosene are also getting bigger so that fractions of kerosene leading to side arm.

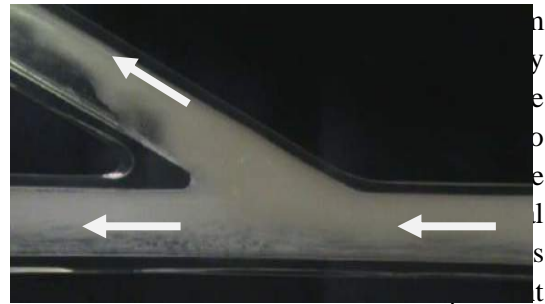
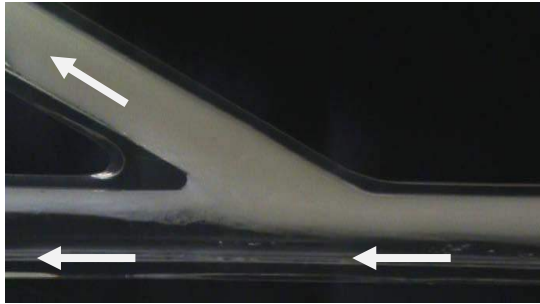

Figure 3. The separation in the speed of Figure 4. The separation in the speed of the mixture $J_{mix} = 0,36$ m./s. the mixture $J_{mix} = 0,43$ m./s

(digital oscilloscope) that terkoneksi with the computer with output the data took the form of the fluctuation signal in the tension, et cetera was analysed to the fluctuation signal in the pressure.

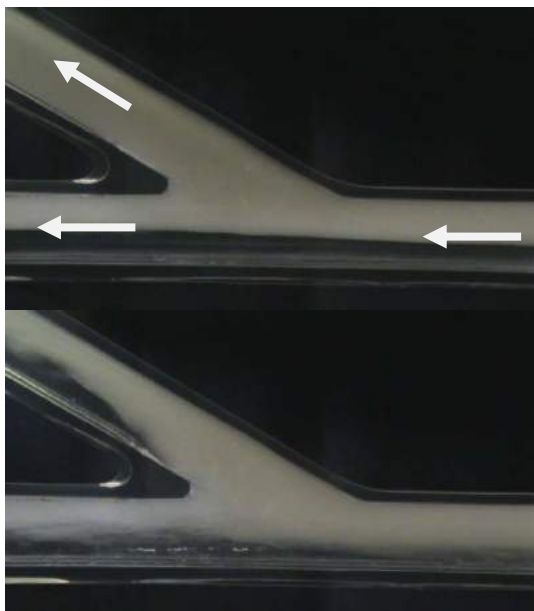

Figure 5. The separation in the Speed of Figure 6. The separation in the Speed of the

themixture of $J_{mix} = 0,52$ m./sthe mixture of $J_{mix} = 0,34$ m./s

The grating of the Superficial Speed towards the Difference of the Pressure:

In this research was carried out by observation of the difference of the pressure by conditioning the superficial speed kerosen constant and the superficial speed water varied. The pattern of the current that was formed as resulting from



Figure 7. The observation point of the pressure in Inlet, Branch and run to Jmix 0,36 m./s

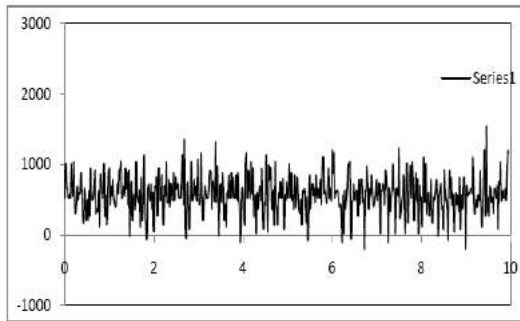

Figure 8. The fluctuation in the pressure
 In *Inlet-Branch* in *Inlet-Branch*

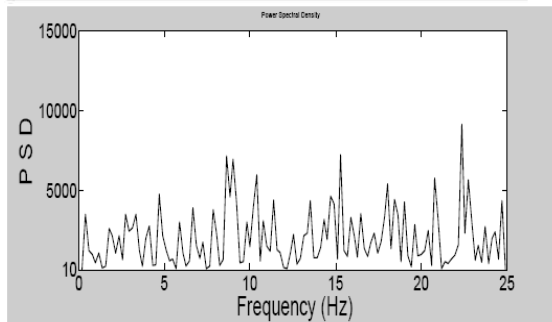

Figure 9. The Signal PSD fluctuation

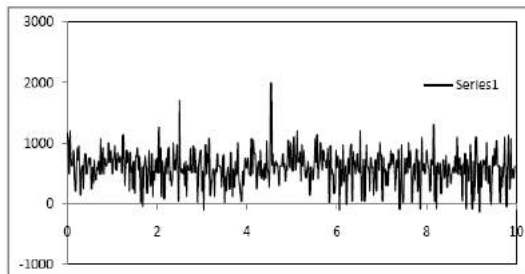
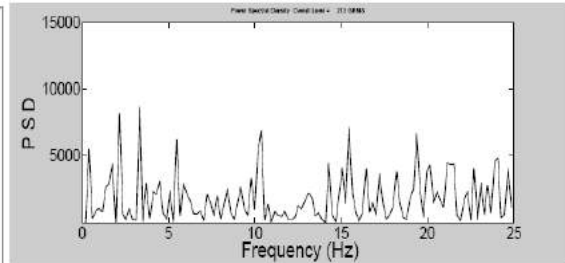

Figure 10. The fluctuation in the pressure
 In *Inlet-Run* in *Inlet-Run*



**The analysis of the Fluctuation in the
Dengan Power Spektra Density Pressure**

(PSD): The analysis spektra was an analysis that was carried out to see the spectrum of the frequency that was contained in the data runtun time (time series the data). The analysis spektra was provided a basis for by the transformation of the data from the time domain to the frequency domain so as the spectrum of the frequency that was contained could be monitored. One of the forms of the transformation that often was used was the Fourier Transformation. The picture 8. Showed generally the fluctuation in the pressure that happened level along inlet-branch, highest 1400 Pa. Even so in the fluctuation signal PSD him

(the picture 9) highest 8000 PSD, in frekkuensi 8, 10, 15, 21, and 23 Hz was seen by the rise was somewhat high. In the condition inlet-run (the picture 10 with the superficial speed water (Jw) as big as 0,30 m/s and the superficial speed kerosene Jk = 0,22 m./s. From the graph was seen that the fluctuation in the highest pressure 2000 Pa, only two points. Was received the frequency the PSD value of the peak 9000 happened in the frequency 2, 3, 5, 10.15, and 20 Hz. Magnitude to PSD descended with the increase in the superficial speed. Gotten by the dominant frequency in the frequency domain and the value of the peak of PSD happened equitable for the length of the frequency. With the increase in the superficial speed kerosene magnitude PSD experienced the decline, and the strength of the peak of PSD experienced the rise (the picture 11). On the whole the fluctuation in the pressure on the PSD analysis of showing the change in the clear frequency, although not

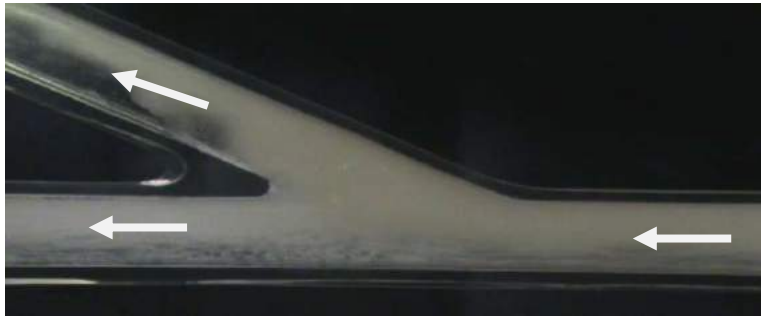

Figure 12. The current of Homogen kerosene-water to $J_{mix} = 0,43$ m/s

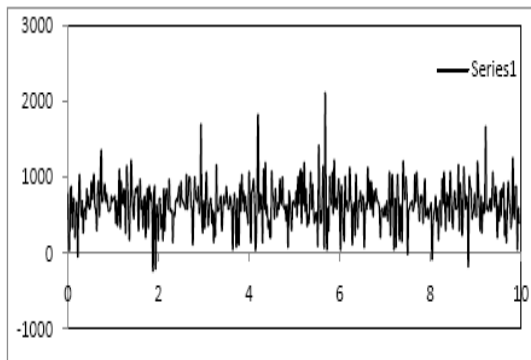

Figure 13. The fluctuation in the pressure
In inlet-Branch in inlet-Branch

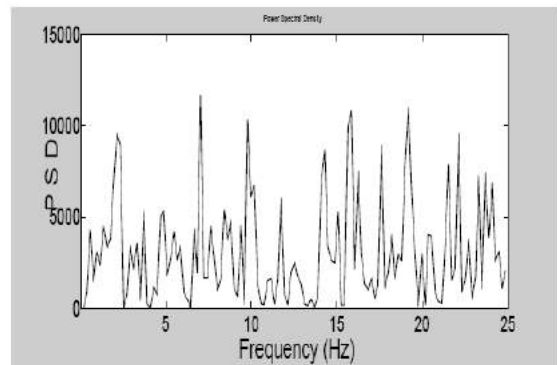

Figure 14. The Signal PSD fluctuation

However in the speed of the mixture of $J_{mix} = 0,43$ m/s the homogeneous current happened kerosene-water (the picture 12) the two phases were mixt and flowed with the same speed. Here was seen that the fluctuation pressure was high enough hingga 2300 Pa (the picture 13), and the fluctuation signal PSD also high and many that is 1300 PSD in the frequency 3, 7, 10.14, 16, 17, 19 and 22 Hz (the picture 14). This showed that increasingly big the value of the speed superficial then will be increasingly big also the value in the pressure that happened of the fluctuation. This was caused with the increase in the speed of the significant fluid of the number of particles of the fluid kerosene that went through the wall even more so as to the tension happen shifted to particles of this fluid that resulted in the increase in the fluctuation in the pressure.

The analysis of the Difference of the Pressure on the Superficial Speed: In the superficial speed of middle water ($0.20 < J_w < 0.30$) and low kerosene was only gotten by 2 layers of the liquid, kerosene on the top and water underneath. The limit between the phase more bergelombang and the thickness of the layer kerosene thinner compared with the pattern of the current that was same in the speed water low. In this condition the fluctuation in the pressure resulting from the occurrence of the fluctuation in the thickness of the layer of the fluid in the limit between the phase happened (the interface) that was stronger.

Moreover the tension shifted also happened in the limit between the phase where kerosene tended spread and formed the layer just took the form of the mixture kerosene and water didaerah the phase limit. The increase in the superficial speed kerosene and the tension shifted resulted in the increase in the fluctuation in the pressure (the picture 8). With the increase in this speed the fluctuation in the quite big pressure happened when certain. Generally in the superficial speed water middle with the increase in the superficial speed kerosene and water constant the decline in

the difference of the pressure on the area happened inlet and run from T-junction (the picture 10).

This change because with the increase in the speed of the significant fluid of the number of particles of the fluid kerosene that went through the wall even more so as to the tension happen shifted to particles of this fluid. Moreover the tension shifted also happened in the limit between the phase where kerosene that his speed low tended spread and formed the layer just took the form of the mixture kerosene and water dibagian on the pipe and the area of the phase limit. The increase in the superficial speed kerosene and the tension shifted resulted in the increase in the fluctuation in the pressure. If the superficial speed kerosene was increased through to 0,22 m/s the pattern of the current that happened was still staying same that is disperse kerosene in water and water homogeneous (the picture 4) where the fluid consisted of the layer water underneath and the mixture on the top with the thickness of the layer of the mixture that increased. With the pattern of this same current of not happening the fluctuation in the quite big pressure. Generally in the superficial speed of high water with the increase in the superficial speed kerosene and water constant the decline in the difference of the pressure on the area happened inlet and run from T-junction (the picture 10). When the superficial speed kerosene increased resulted in the increase in the momentum of the mixture, the style of inertia to the side of side arm bigger and tended the fluid kerosene more dominant flowed to the side of side arm

Pressure relations downstream towards the speed superficial: From results pengukuran was seen (the picture 12) that with the obstacle to the valve downstream 40% pressure downstream will continue to rise together with the speed increase superficial. The increase in the superficial speed kerosene and the tension shifted resulted in the increase in the fluctuation in the pressure downstream. Likewise to the

obstacle to the valve downstream 78% and 90%. However to the obstacle to the valve downstream 90% happened the rise in the pressure downstream was significant enough and berfluktuatif. It was increasingly big that the value of the speed kerosen (Jk) then increasingly big also the pressure downstream that happened.

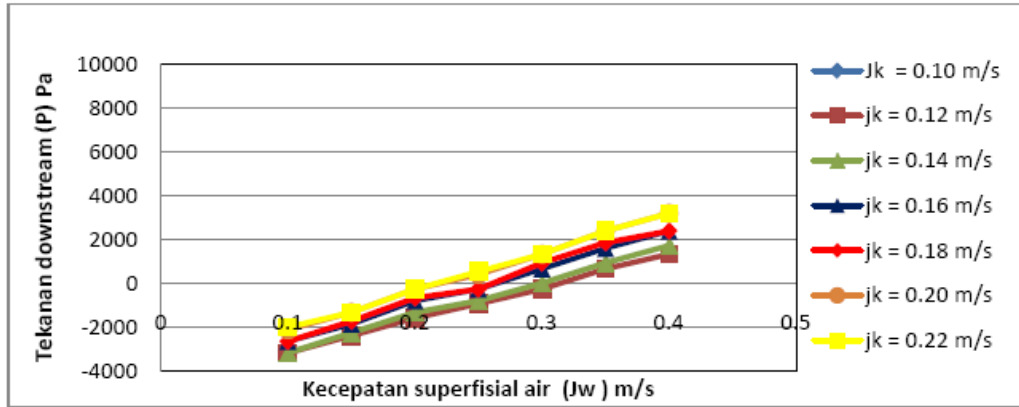

Figure 15. Obstacle to downstream valve 40%

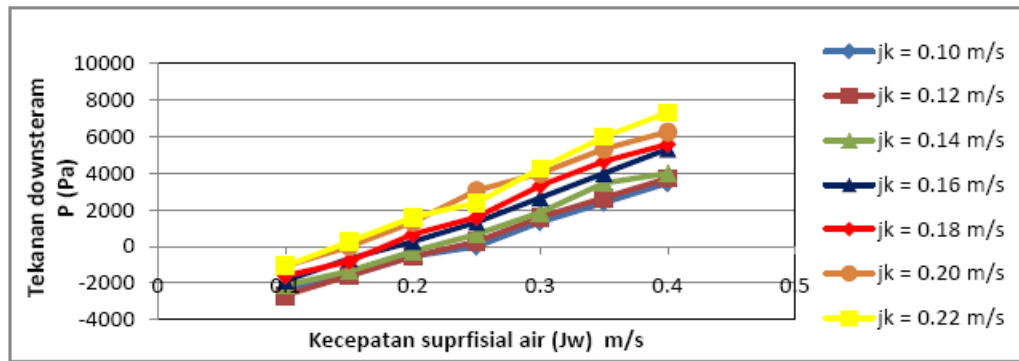

Figure 16. Obstacle to downstream valve 78%

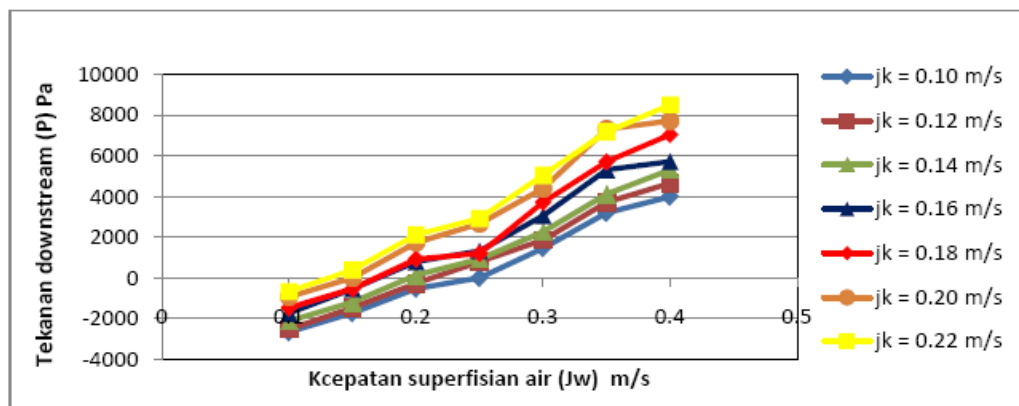

Figure 17. Obstacle to downstream valve 90%

CONCLUSION

Based On the research and results of the analysis of the data that was carried out could be taken by several conclusions as follows:

1. On the whole results of the separation of the best phase happened in water cut 58 %, $J_{mix} = 0,36$ m./s, with the obstacle to the current downstream in the pressure 550.7 Pa produced $F_k = 97$ % and $F_w = 2$ % that flowed to side arm, and $F_k = 3$ % and $F_w = 98$ % that flowed to run arm. And separation efficiency of the phase that was high of 99 % happened in water cut 64 %, $J_{mix} = 0,36$ m./s, $F_m = 0.51$ and $x_1 = 0.51$ with the obstacle to the current downstream 40% in the pressure 550 Pa. It was increasingly small that thought water cut increasingly good separation efficiency that was achieved.
2. Magnitude to PSD descended with the increase in the superficial speed kerosene reached $J_k = 0,18$ m./s. Gotten by the dominant frequency in the frequency domain and the value of the peak of PSD happened equitable for the length of the frequency. With the increase in the superficial speed kerosene magnitude PSD experienced the decline, and the strength of the peak of PSD experienced the rise.
3. The increasing speed of the shear stress of kerosene and superficial result in increasing pressure fluctuations. With the speed increase occurs considerable pressure fluctuations at any given time. On a superficial water medium speed with increasing speed of superficial water and kerosene for constant pressure difference loss occurring on the area of the inlet and run T-junction
4. The increasing speed of the shear stress of kerosene and superficial result in increasing pressure fluctuations downstream. Increased pressure downstream of the Pa tertinggi

2018,3 case on the drag valve downstream of 90% and the value of the speed of kerosene (J_k) highest i.e. 0.22 m/s

BIBLIOGRAPHY

- Angeli, P and Hewitt, G.F. 1998. *Flow Structure in Horizontal Oil-Water Flow*. International Journal of Multiphase Flow. Vol-26. pp 1117-1140.
- Gunawan, 2009, *Studi Eksperimental Mengenai Perubahan Pola Aliran Terhadap Perubahan Tekanan Pada Aliran Kerosene-Air di T-Junction*, Tesis S2 Teknik Mesin UGM, Yogyakarta.
- Koestoer, R.A. dan Sasanti, P., 1994. *Aliran Dua Fase dan Fluks Kalor Kritis*, Pradnya Paramita, Jakarta.
- Lovick, J., and Angeli, P. 2003. *Experimental Studies On The Dual Continuous Flow Patern in Oil-Water Flows*. International Journal of Multiphase Flow. Vol-30. pp 139-15.
- Rodriguez, O.M.H. and Oliemans, R.V.A. 2005. *Experimental Study on Oil-Water Flow in Horizontal and Slightly Inclined Pipes*. International Journal of Multiphase Flow. Vol-32. pp 323-343.
- Seeger, W., Reimann, J. and Muller, U., 1985, *Two-Phase Flow in a T-junction with A Horizontal Inlet*. International Journal of Multiphase Flow, Vol-12, pp. 587-608.
- Yang L, B.J Azzopardi, A. Belghasi, 2006. *Phase separation of liquid-liquid two-phase flow at a T-junction*. AIChE Journal. Vol. 52(1), pp. 141-149.
- Wang Li-yang, Wu Ying-xiang, Zheng Zhi-chu, Guo Jun, Zhang Jun, Tang Chi, 2002. *Oil-water two-phases*

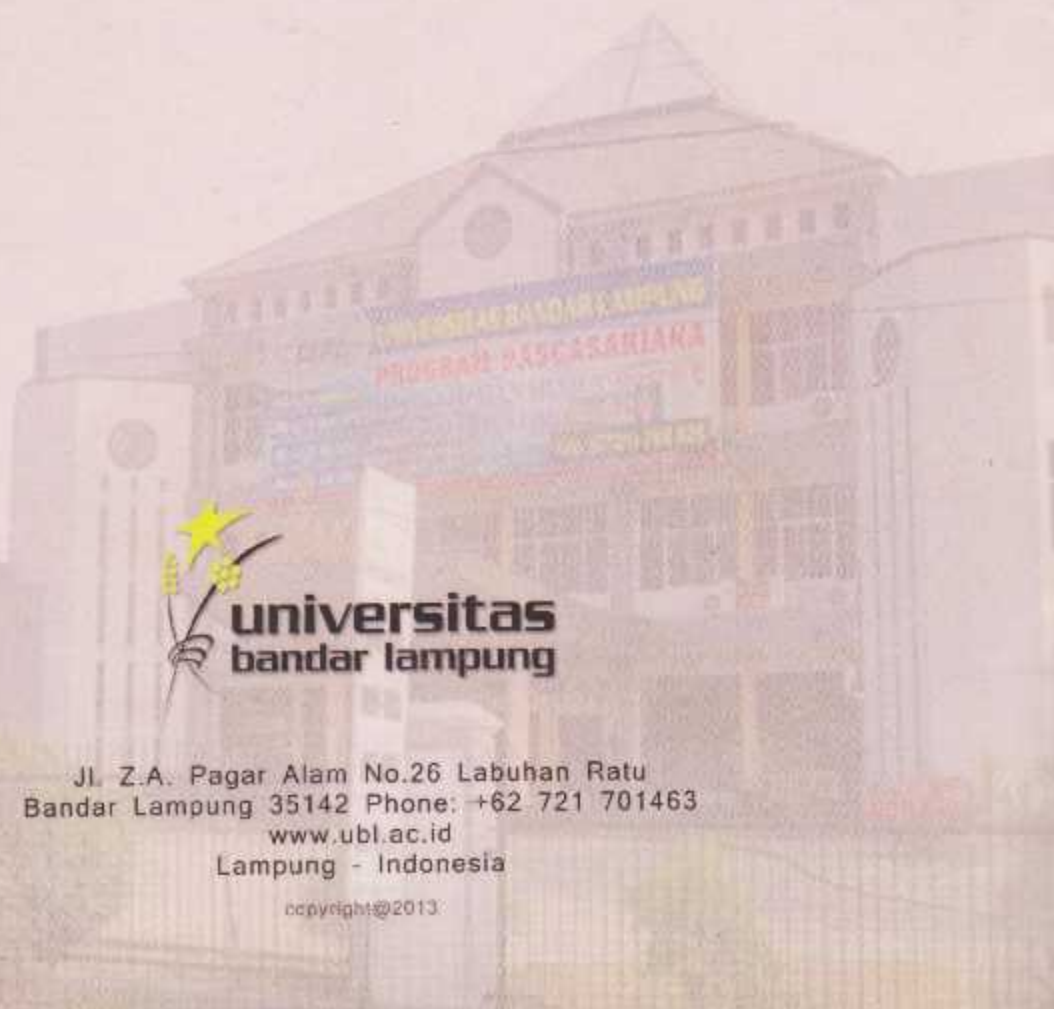

**universitas
bandar lampung**

Jl. Z.A. Pagar Alam No.26 Labuhan Ratu
Bandar Lampung 35142 Phone: +62 721 701463
www.ubl.ac.id
Lampung - Indonesia

copyright © 2013