

Settlement of a Full Scale Trial Embankment on Peat in Kalimantan: Field Measurements and Finite Element Simulations

Endra Susila

Soil Mechanics Laboratory, Faculty of Civil and Environmental Engineering, Institut Teknologi Bandung
Jl. Ganesa No. 10, Bandung 40132, Indonesia. E-mail: esusila@si.itb.ac.id, endrasusila@gmail.com

Dayu Apoji

AECOM Singapore Pte. Ltd. 300 Beach Road, #03-00 The Concourse, Singapore 199555, Singapore; Formerly
Graduate Research Assistant, Soil Mechanics Laboratory, Institut Teknologi Bandung, Jl. Ganesha No. 10
Bandung 40132, Indonesia. E-mail: dayu.apoji@aecom.com, dayu.apoji@gmail.com

Abstract

This paper presents a study result of peat behaviors through numerical analysis using the finite element method verified by full scale field measurements. Site investigation, construction, instrumentation and monitoring of a trial embankment on very compressible fibrous tropical peat layers at Bereng Bengkel in Central Kalimantan have been conducted by the Agency of Research and Development, the Indonesia Ministry of Public Works. Settlement responses of the embankment have been investigated by a series of finite element simulations using two different soil constitutive models: elastic perfectly plastic model with the Mohr-Coulomb criteria and hyperbolic Hardening-Soil model. A half space finite element model has been developed using the effective stress approach. Analyses were performed with the coupled static/consolidation theory. The soil parameters, embankment geometry, construction sequence and consolidation time of peats and clays were modeled in accordance with actual field trial embankment conditions. Implementation of the numerical model and simulations has completely been performed by a computer program, PLAXIS 2D. For ground settlement behavior at center of embankment, this study result shows that both soil constitutive models have reasonably produced suitable deformation behaviors. However, the settlement behaviors at embankment toes are not as accurate as they are at center.

Keywords: Peat, trial embankment, full scale, field test, numerical analysis, finite element method, constitutive model, elastic perfectly plastic, hardening-soil, Kalimantan, Indonesia.

Abstrak

Makalah ini menyajikan studi perilaku gambut melalui analisis numerik berdasarkan metode elemen hingga yang diverifikasi dengan pengukuran lapangan skala penuh. Investigasi lokasi, konstruksi, instrumentasi dan pengukuran timbunan di atas lapisan gambut tropis berserat yang sangat kompresibel di Bereng Bengkel, Kalimantan Tengah, telah dilakukan oleh Departemen Penelitian dan Pengembangan dari Departemen Pekerjaan Umum Indonesia. Respon penurunan timbunan ini telah dianalisis melalui serangkaian simulasi numerik elemen hingga menggunakan dua model konstitutif tanah: model elastis plastis sempurna dengan kriteria keruntuhan Mohr-Coulomb dan model hiperbolik Hardening-Soil. Model elemen hingga setengah ruang telah dibuat dengan pendekatan tegangan efektif. Seluruh tahapan simulasi telah diperhitungkan sebagai analisis statis/konsolidasi couple. Parameter tanah, geometri timbunan, tahapan konstruksi dan waktu konsolidasi gambut dan lempung dimodelkan sesuai dengan kondisi lapangan. Implementasi dari model dan simulasi numerik ini telah dilakukan menggunakan program komputer PLAXIS 2D. Untuk perilaku penurunan tanah di tengah timbunan, studi ini menunjukkan bahwa kedua model konstitutif tanah dapat menghasilkan perilaku deformasi yang cukup sesuai. Namun, prediksi perilaku penurunan tanah di kaki timbunan tidak seakurat prediksi perilaku di tengah timbunan.

Kata-kata Kunci: Gambut, timbunan, uji lapangan skala penuh, analisis numerik, metode elemen hingga, model konstitutif, elastic perfectly plastic, hardening-soil, Kalimantan, Indonesia.

1. Introduction

Peat is a mixture of fragmented organic materials which are derived from vegetation that have been

chemically changed, generally, and fossilized for a long time (Dhowian and Edil 1980; Huat et al. 2009; Kulathilaka, 1999). This material has unique mechanical behaviors. The material is found in many parts of

the world, for example the United States, Canada and Russia which have areas of peat of 30, 170, and 150 million hectares, respectively (Hatlen and Wolski, 1996). Currently, Indonesia has approximately 26 million hectares of peat (Huat et al., 2009). **Figure 1** shows peat areas in Indonesia.

Nowadays, due to the excessive increasing world population and urbanization, the need of utilization of peat area becomes apparent. The price of property in such cases is more expensive than the required treatment of the land. In other cases, construction faces the lack of suitable land. The problem is, peat has caused many geotechnical problems due its characteristics of high compressibility and low shear strength. These lead to the emergence problems of large settlement, low bearing capacity and long consolidation time. In addition, it was found that important anomalies existed in peat behavior which required special considerations/treatments on engineering the peat material. Thus, determination of soil constitutive model and soil parameters is critical to obtain reliable prediction of geotechnical condition and consequences, to obtain suitable solution and to decide the suitable construction techniques.

This paper presents a study result of peat behaviors through numerical analysis using the finite element method verified by full scale field measurements of a trial embankment. Site investigation, construction, instrumentation and monitoring of a trial embankment on very compressible fibrous tropical peat layer at Bereng Bengkel, Central Kalimantan, have been conducted by the Agency of Research and Development, the Indonesia Ministry of Public Works. This trial embankment construction was conducted as a part of soft soil engineering research cooperation between Ministry of Public Works (PU) of Indonesia and Ministry of Transport, Public Works and Water Management (Rijkswaterstaat) of The Netherlands

(Final Report IGMC Guide Phase 1, 1998; Progress Report IGMC Guide Phase 2, 2001).

In this study, settlement responses of the embankment have been investigated by series of finite element numerical simulation using two different soil constitutive models: elastic perfectly plastic model with the Mohr-Coulomb criteria and hyperbolic Hardening-Soil model. The soil parameters, embankment geometry, construction sequence and consolidation time of peats and clays were modeled in accordance with actual field conditions. Implementation of the numerical model and simulations has been completely performed by a computer program PLAXIS 2D.

2. Peat Properties and Behaviors

2.1 Definition and classification

As mentioned earlier, Dhowian and Edil (1980), Huat et al. (2009) and Kulathilaka (1999) defined Peat as a mixture of fragmented organic materials derived from vegetation that has been chemically changed and fossilized. The unique prominent properties of the material are very high void ratios and very high water content. The material is commonly formed in wetlands under appropriate climatic and topographic conditions. Warburton et al. (2004) defined peat as a biogenic deposit which when saturated consists of approximately 90% to 95% water and approximately 5% to 10% solid parts. Further, the organic content of the solid fraction is often up to 95%. This organic content is made up of partly decayed remains of vegetation which have accumulated in waterlogged areas over timescales of a hundred years.

Observation of the physical peat model indicates that the soil can be divided into two major components, for instance: (1) organic bodies, which consist of organic particles with its inner voids filled with water; and (2)

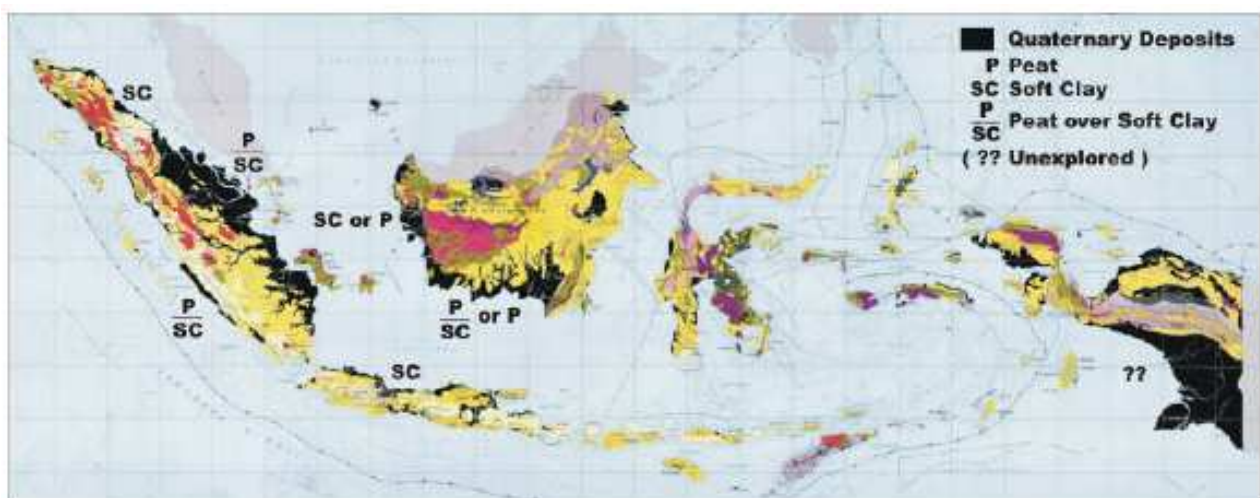

Figure 1. Peat location in Indonesia (GeoGuide, 2002)

organic spaces, which comprises of soil particles with its outer voids fill with water. This concept of multi-phase system of peat and development of physical peat soil model was introduced by Kogure et al. (1993). Based on the earlier findings, Wong et al. (2009) developed a schematic diagram of peat indicating the soil composition (**Figure 2**). **Figure 2** also shows photomicrograph of a poriferous cellular peat particle. It is explicable how peat can hold considerable amount of water by deciphering its construction of physical component.

Peat can be classified as fibrous peat and amorphous peat (Dhowian and Edil, 1980). Peat is considered as fibrous peat if the peat has 20% fiber content or more. If the peat has less than 20% fiber content it is considered as amorphous peat. Further, Karlsson and Hansbo (1981) differentiated fibrous peat from amorphous peat with several descriptions, for instance: low degree of decomposition, fibrous structures and easily recognized of plant structure. Amorphous peat has a high degree of decomposition. Thus it has lower water holding capacity compared to that of fibrous peat. Visualization of amorphous and fibrous peat comparison is shown in **Figure 3**

2.2 Physical properties

Peat has a variety of unique behaviors and high water contents. Based on previous studies, peat has variation of natural water contents from approximately 400% (Ferrell & Hebbib 1998; Weber 1969) to more than 1500% (Lea & Browner 1963; Lefebvre et al. 1984). In its particular classification, amorphous granular peat can have an initial moisture content of 500% while fibrous peat can be as high as 3000% (Bell, 2000).

In addition to its huge water storage capacity, Bell (2000) also stated that amorphous peat tends to have higher bulk density than fibrous peat. Bell (2000) found that amorphous peat bulk density can range up to 12 kN/m³ while fibrous peat bulk density possibly up to half to that. These density values are comparable to other findings which are ranging from 8 kN/m³ to 12 kN/m³ (Gosling & Keeton 2008; Huat et al. 2009; Rowe et al. 1984a). Terzaghi et al. (1996) stated that peat void ratio ranges from 11.1 to 14.2. Bell (2000) suggested the void ratio of 9 for amorphous peat to 25 for fibrous peat, with the specific gravity of 1.1 to 1.8.

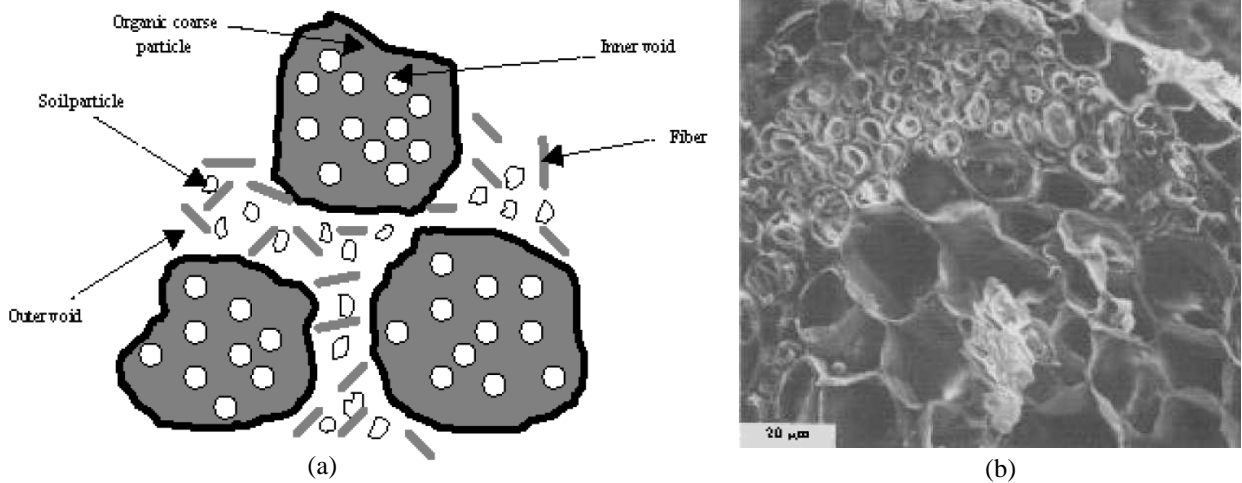

Figure 2. Peat: (a) Schematic diagram illustrating the composition of peat (Wong et al., 2009); (b) Photomicrograph of a poriferous cellular peat particle (Terzaghi et al., 1996)

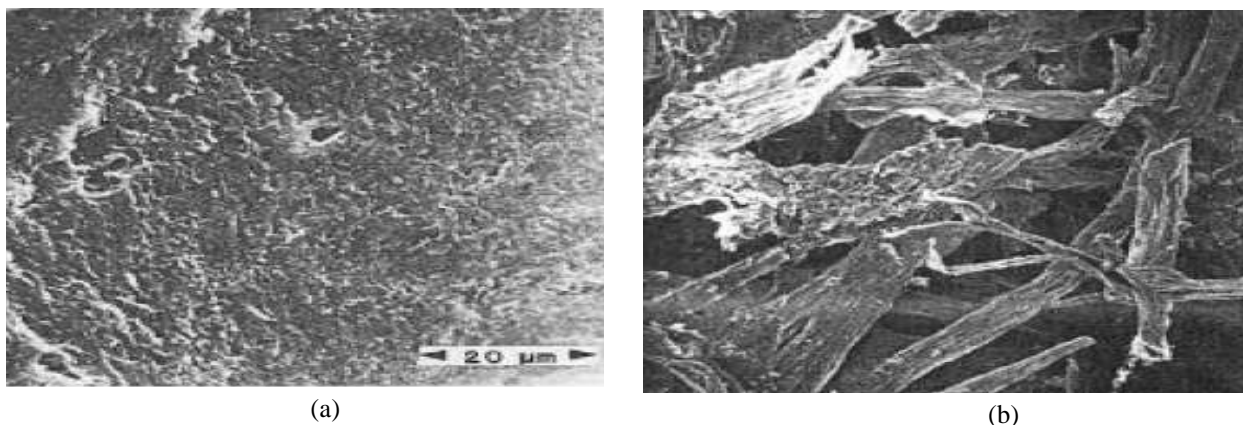

Figure 3. Micrographs of peat (a) Amorphous-granular material in its natural state (Landva and Pheeny, 1980); (b) horizontal plane fibrous peat (Fox and Edil, 1996)

2.3 Hydraulic conductivity

The construction of physical component in peat significantly affects the size and continuity of its pores resulting in a wide range of hydraulic conductivities (Edil, 2003). Findings on the initial hydraulic conductivity of peat revealed that the initial coefficient of vertical permeability (k_{v0}) of the soil ranged from $10E-5$ to $10E-8$ m/s (Wong et al., 2009). It should be noted that the amorphous peat value was found to be lower to fibrous peat. Dhowian and Edil (1980) found that this permeability change noticeably as a result of compression (Figure 4).

Dhowian and Edil (1980) further stated that for approximately the same void ratio, the coefficient of horizontal permeability (k_h) was approximately 300 times larger than its coefficient of vertical permeability (k_v). This finding proves the anisotropic behavior of peat while also give other implication: at a consolidation pressure, its coefficient of horizontal consolidation (c_h) was greater than its coefficient of vertical consolidation (c_v).

2.4 Compressibility

Generally, peat is considered as difficult soil which has high rate of primary consolidation and a significant stage of secondary compression (Colleselli et al. 2000). In several cases, this compression is not constant with logarithm of time. This fact is supported by other researcher findings, such as Berry and Vickers (1975) and Gofar and Sutejo (2007). Berry and Vickers (1975) find that the deformation process of peat involves two sepa-

rated but interlinked effects associated with primary pore pressure dissipation and secondary viscous creep.

Further, four strain components of peat has been observed by Dhowian and Edil (1980); Wong et al (2009). They conclude that components are: (1) instantaneous strain, which occurs immediately after the application of a pressure increment, possibly the result of the compression of air voids and the elastic compression of the peat, (2) primary strain, which occurs at a relatively high rate and continues for several minutes to a time, t_p , (3) secondary strain, which results from a linear increase of strain with the logarithm of time for a number of additional log cycles of time until a time, t_s , and (4) tertiary strain, which continues indefinitely until the whole compression process ends.

Based on previous studies, ratio between coefficient of secondary compression and coefficient of primary compression (c_s/c_c) is approximately 0.035 (Lea & Brawner 1963) to approximately 0.091 (Keene & Zawodniak 1968). Results from oedometer tests on Portage peat show that while the coefficient of secondary compression ranges from 0.17 to 0.18, its coefficient of tertiary compression varies from 0.6 to 0.18 (Dhowian and Edil 1980; Wong et al. 2009).

2.5 Strength and stiffness

McGeever (1987) concluded that peat usually has significant anisotropy stress behavior. This usually produces different value of effective shear strength from every different type of test. He also concluded that determination of effective strength parameters of peat from drained tests was not possible. This is caused by the values of deviatoric stress and volumetric strain continues to increase during test, even when it has reached 50% of strain. On the other study, Rowe et al. (1984b) claimed have been able to determine the effective stress parameters of natural peat in Aurora, Ontario, from a series of drained simple shear, direct shear, and tension tests. Results from these tests were consistent; showed that the effective cohesion (c') ranged from 1.1 to 3.0 kPa while its effective angle of internal friction (ϕ') ranged from 26 to 27°. Suitable with McGeever statement, Rowe et al. (1984b) were not able to determine the effective stress parameters using triaxial test. They reported triaxial tests gave a strength envelope with $c' = 0$ and $\phi' = 54^\circ$. This value is very high and gave underestimate deformation results in their field validation.

Beside determined its effective stress parameters, Rowe et al. (1984b) also developed a correlation between undrained shear strength values from vane shear tests and its Young's modulus, E for peat at that site (Figure 6). This figure shows that the Young's modulus of peat even could be less than $30S_u$ in low stress condition.

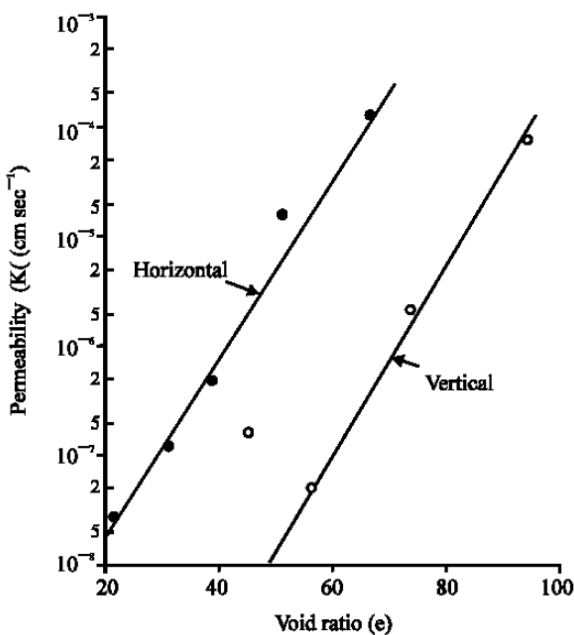

Figure 4. Coefficient of permeability versus void ratio for vertical and horizontal specimens of Portage peat (Dhowian and Edil, 1980)

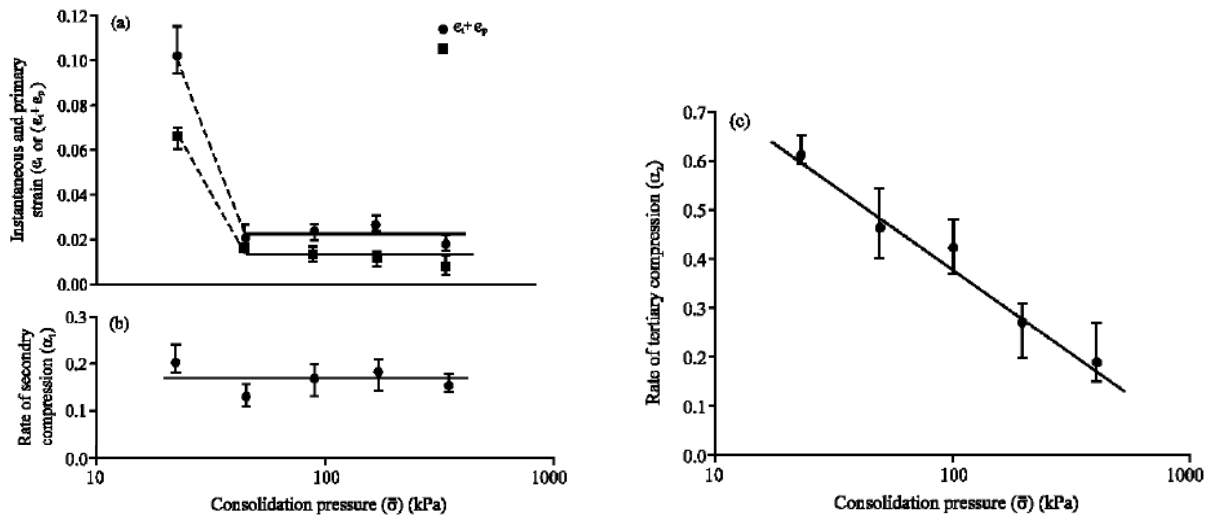

Figure 5. Compression parameters versus consolidation stress for Portage peat (Dhowian and Edil, 1980)

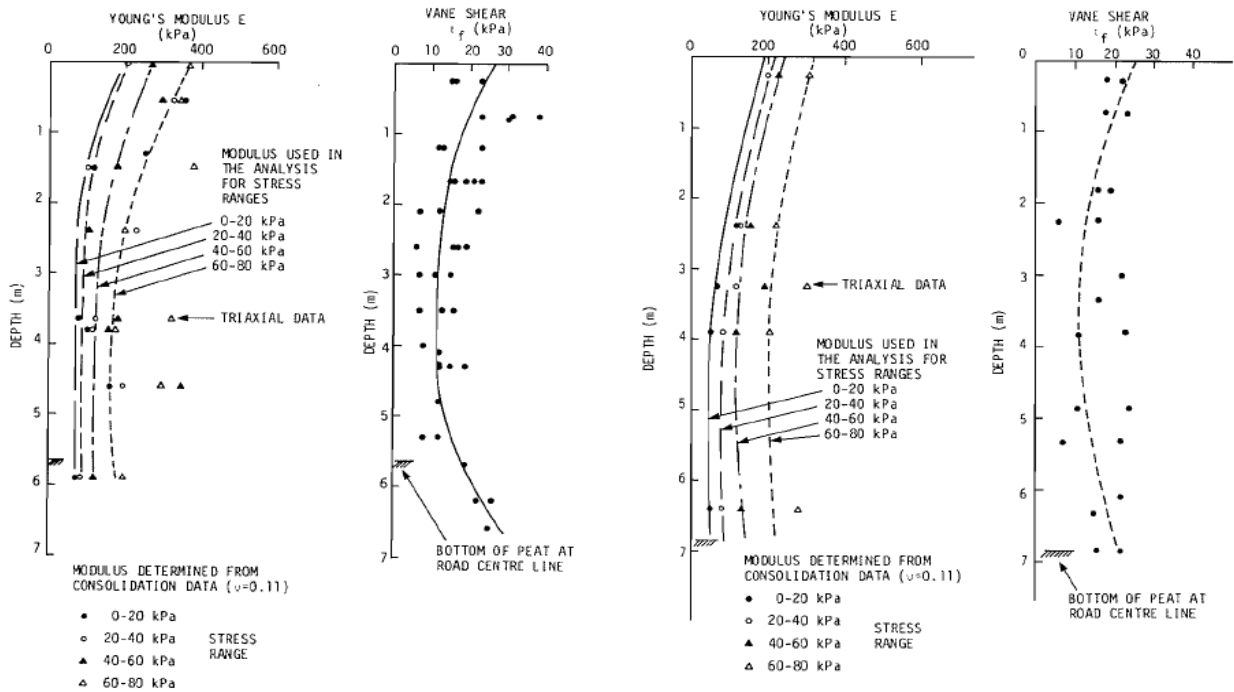

Figure 6. Variation in Young's modulus and vane strength with depth at two sites in Ontario (Rowe et al., 1984b)

3. Ground Condition

To investigate the subsurface condition of Bereng Bengkel site, one (1) borehole, three (3) cone penetration tests (CPTs) and two (2) vane shear tests (VSTs) were executed in this trial embankment area. The investigation was coordinated and conducted by Agency of Research and Development, the Indonesia Ministry of Public Works. The exploration found a substantial organic soil deposit of peat from the ground surface to an approximate depth 3.5 meters below the existing ground surface. Interpretation of CPT results predicts an average undrained shear

strength value of this peat layer of 9 kPa, while further tests interpretation concludes its effective strength parameters of 1 kPa and 27° for cohesion (c') and angle of internal friction (ϕ'), respectively.

Similar to general properties of peat deposits, the nature of the Bereng Bengkel peat are varied, ranging from a fibrous peat with an approximate fiber content of 38.1% to predominantly amorphous peat with an approximate fiber content of 19.5%. The average moisture content of this layer was 940% while the average value of initial void ratio (e_0), coefficient of compressibility (c_c) and coefficient of

recompression (c_r) were 12.11, 5.20 and 0.26, respectively. The values of compressibility parameter give an approximate c_r/c_c ratio of 0.05, in the range suggested by Bowles (1996) which suggests the values of 0.05 to 1.0. The laboratory test results revealed that the average permeability value of peat at the studied site was $5.24E-8m/s$.

This peat was underlain by approximately 6 meters of medium stiff clays. Based on CPT and laboratory tests, this layer could be considered as slightly overconsolidated (OC) clay with an overconsolidation ratio (OCR) of slightly more than 2.0. The OCR correlation from CPT data was determined according to Kulhawy and Mayne (1990). Based on interpretation of field and laboratory tests, it was found that the undrained shear strength of this layer ranged from 30 to 60 kPa with effective strength parameters of $c' = 10$ kPa and $\phi' = 28^\circ$. Further, the average values of initial void ratio (e_0), coefficient of compressibility (c_c) and coefficient of recompression (c_r) were 1.02, 0.26 and 0.05, respectively. The values of compressibility parameter give the approximate c_r/c_c ratio of 0.18, still in the ranges suggested by Das (2002) of 0.1 to 0.2. The laboratory test results showed that the average permeability value of this clay was approximately $1.23E-9m/s$. This medium stiff clay layer ended at an approximate depth of 9.5 meters below the existing ground surface.

CPT interpretation figured out that soft clay layer encountered below the medium stiff clay layer, from approximate depth of 9.5 to 18 meters below the existing ground surface, where the hard layer was

encountered. However, since the borehole ended at approximate depth of 7.5 meters below ground surface, there was no laboratory data available for this layer. Interpretation of CPT found that the undrained shear strength of this layer ranged from 20 kPa to 40 kPa with effective strength parameters of $c' = 1$ kPa and $\phi' = 15^\circ$. Most parameters in this layer were determined based on its similarity with previous clay layer and other available soil correlation.

Finally, hard layer was identified at an approximate depth of 18 meters below the existing ground surface, where all of the CPT could not continue its penetration. Maximum tip resistances of cone at this depth were 150 kg/cm^2 . This layer is assumed not to give any contribution to the deformation behavior in the numerical analysis. Thus, this hard layer could be considered as a boundary condition.

4. Embankment and Instrumentation

The 4 meter high trial embankment was constructed on a natural tropical peat deposit at Bereng Bengkel in the Central Kalimantan Province. This trial embankment construction and monitoring were also coordinated and conducted by Agency of Research and Development, the Indonesia Ministry of Public Works. Wooden mats were placed on the ground surface to give a platform for the embankment. The main function of this platform was to give local stability for the embankment. However, both Rowe et al. (1984) and Siavoshnia et al. (2010) found that the presence of this geotextile type of platform as well as its stiffness did not have

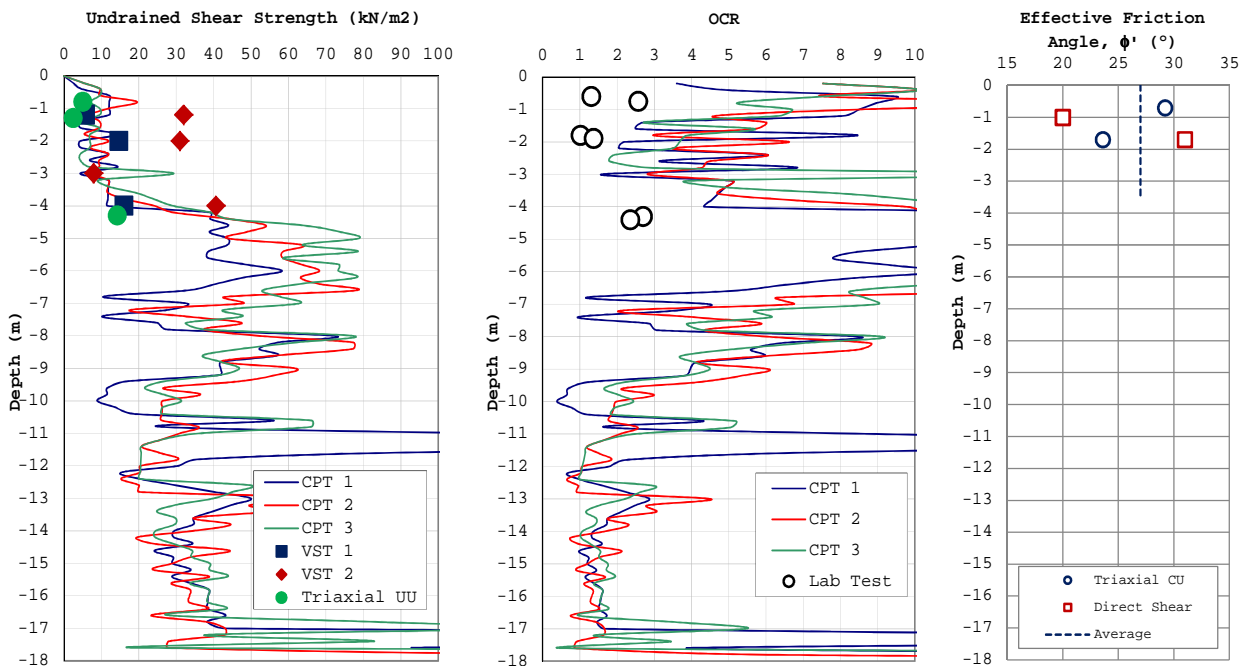

Figure 7. Shear strength of peat and clay: (a) undrained shear strength, (b) OCR, and (c) effective friction angle

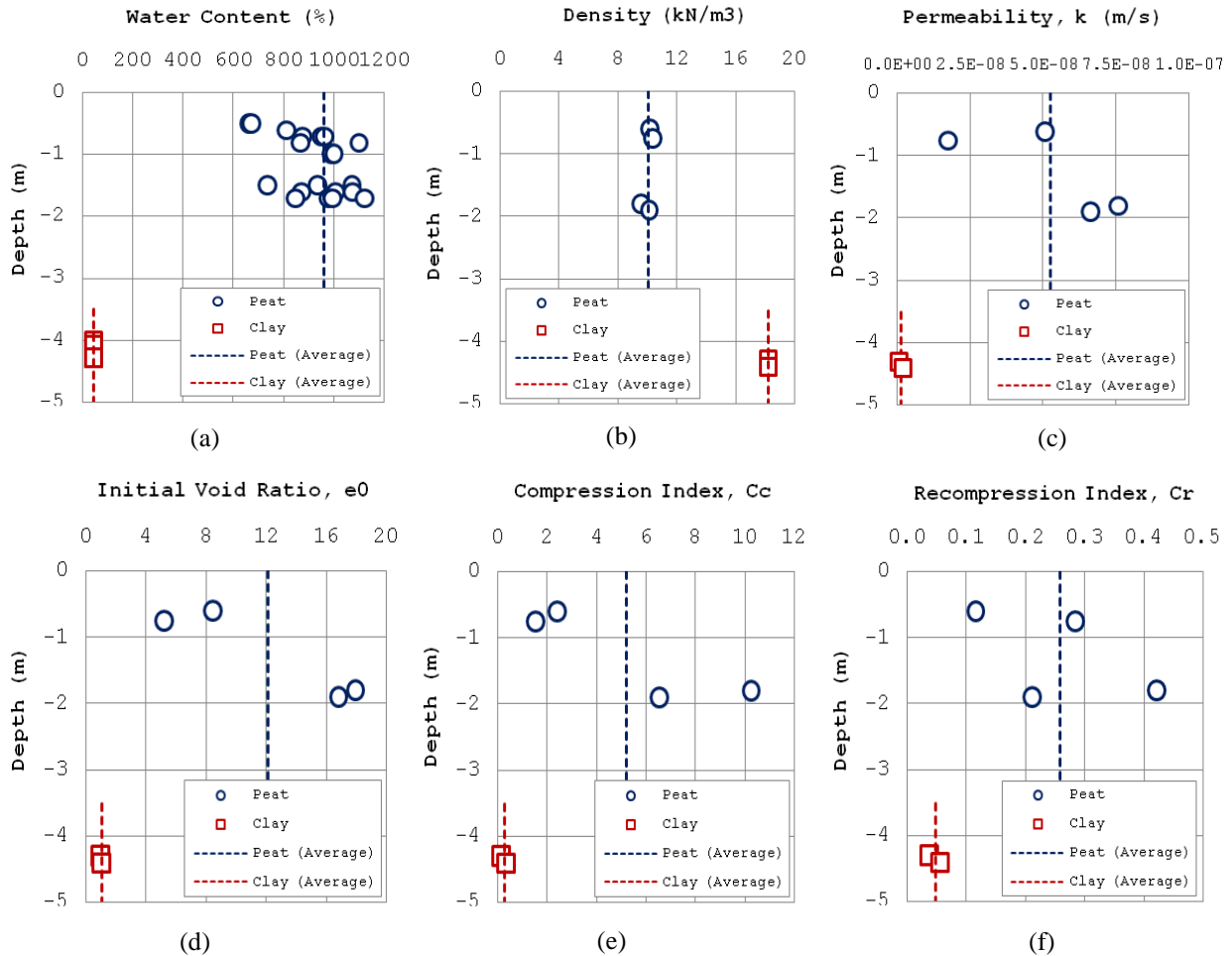

Figure 8. Physical and compressibility properties of peat and clay: (a) natural water content, (b) natural density, (c) permeability, (d) initial void ration, (e) compression index and (f) recompression index

significant influence on the deformation behavior of embankment, particularly in vertical direction (settlement).

The construction of the embankment was conducted using a common fill with an approximate density of 20 kN/m³ and an approximate angle of internal friction (ϕ') of 32°. The dilatancy angle of fill was assumed to be zero. The longitudinal and cross sections of the test embankment are shown schematically in **Figure 9**.

For studying its behavior, the embankment was instrumented with several monitoring devices: settlement plates, piezometers, magneto extensometers and inclinometers (**Figure 10**). Settlement behavior of the trial fill was monitored with settlement plates (SP). This study focuses on the settlement (vertical deformation) behavior. Lateral deformation measured by the inclinometer was not incorporated in this analysis. In this study, two settlement plates, SP-8 and SP-10 were selected to observe the settlement behavior. The SP-8 was located at the center of the embankment

and SP-10 was located at the toe of the embankment. Both SPs were placed on the existing ground surface and below the embankment fill

5. Model and Parameter

5.1 Soil constitutive model and parameters

Soil behaviors can be modeled with various levels of complexity depending on the level of intended accuracy and available parameters. In general, more detail input parameters will result in more accurate results. However, more advance models with require more input parameters which usually are less practical for general use and/or simple problems. Even with its shortcomings, the elastic perfectly plastic model with the Mohr-Coulomb (MC) criteria is still very popular for routine applications of engineering practice due to its simplicity of required parameters (Termaat, 1994). In this study, two soil constitutive models are selected: Mohr-Coulomb model and Hardening-Soil model.

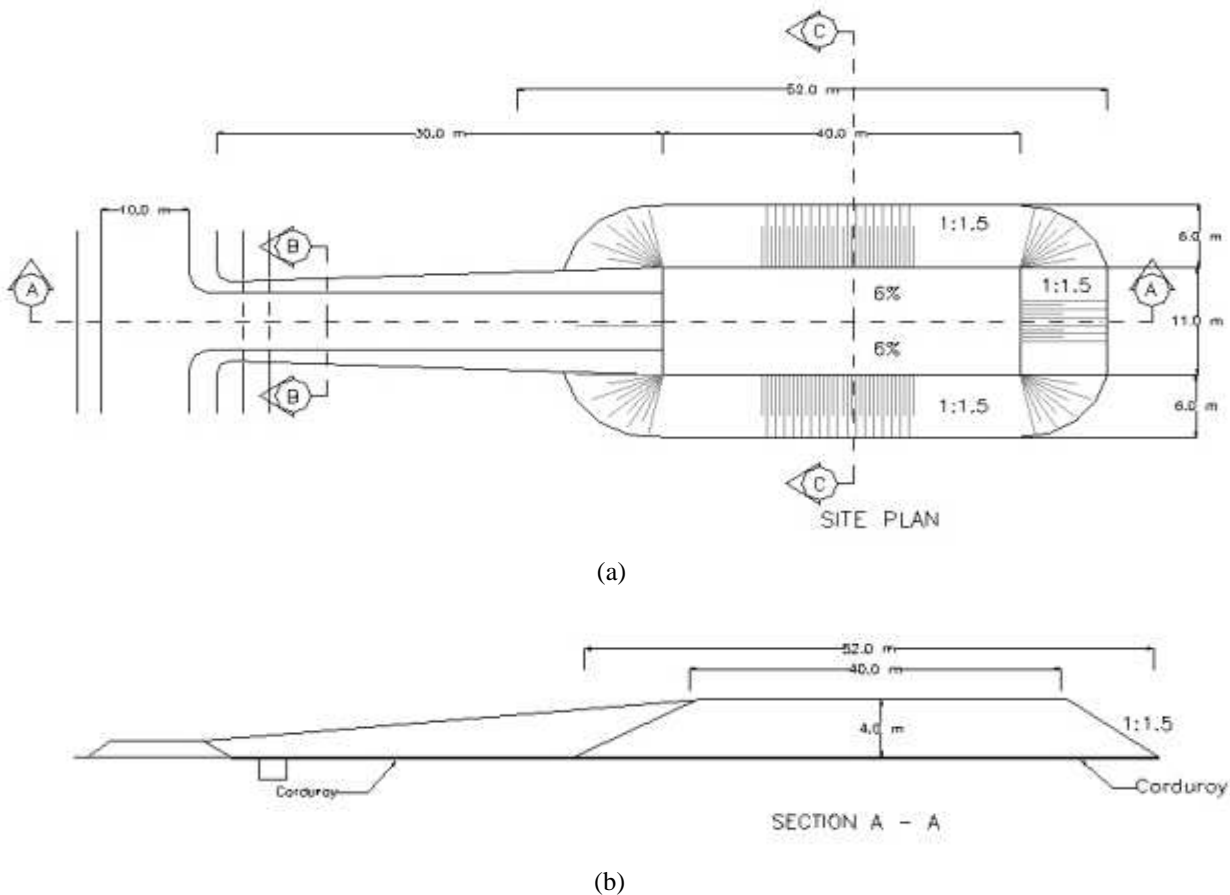

Figure 9. The trial embankment: (a) top view, (b) longitudinal section and (Agency of Research and Development, Ministry of Public Works, 1998)

The MC model requires five (5) input parameters: stiffness modulus (E), Poisson ratio (ν), cohesion (c), friction angle (ϕ) and dilation angle (ψ). In this model, the soil stiffness (E) is modeled constant for each layer independent to depths. The effect of overburden is considered during selection of E .

Similar to the MC model, the plasticity limit of soil in Hardening-soil (HS) model is controlled by the values of c and ϕ . However, in this model, the soil stiffness parameters are described more accurately with 3 input parameters: loading stiffness modulus E_{50} , the unloading stiffness modulus E_{ur} and the oedometer stiffness modulus E_{oed} . This model has a hyperbolic stress-strain relation and accounts stress-dependency behavior of stiffness modulus in soil. This means that the stiffness increases as the overburden pressure increases (Schanz et al. 1998; Schanz et al. 1999). Basic concepts of the elastic perfectly plastic and hyperbolic model are shown in **Figure 11**.

In this study, the finite element analyses were performed using effective stress approach. With this approach, a single set of effective shear strength parameters of a soil is used for all confining pressure states. A couple formulation will determine the values of

undrained shear strength as well as its shear strength increase due to dissipation of excess pore water pressure during consolidation. The relation of effective stress – pore water pressure – deformation of MC model and HS model in finite element calculation has been studied by Apoji and Susila (2012). The shear strength parameters which used in this study were obtained based on field and laboratory test results.

Stiffness modulus, E , will play a significant role in deformation behavior analysis of soils. Unfortunately, based on collected data from this trial embankment research, there was no particular field or laboratory test conducted to obtain this parameter. Thus, the stiffness modulus was determined based on available data and correlations. For MC model, a single stiffness parameter (E) which has to be determined manually for each confining pressure. A correlation of $E = 30S_u$ layer under low pressure condition (about 10 to 30kPa) appears appropriate for peat (Rowe et al. 1984). In HS model, by calibrating a reference pressure, a single set of these deformation parameters can be used for all confining pressure states. With its reference pressure of 100kPa, the correlation of peat stiffness modulus will be adjusted to $E_{50}^{ref} = 120S_{-u}$. Complete parameters of all soil layer used for this study are compiled in **Table 1**.

5.2 Finite element model

Half space finite element models of the trial embankment have been developed to conduct this study. The finite element simulations were performed with the plane-strain model. The 15 node elements were selected. Geometry of models was developed in accordance to actual trial embankment geometry. The bottom of model was fixed in both vertical and horizontal directions. Both edges of the models were restricted from horizontal movement. The ground water level was modeled as a phreatic level at an approximate depth of 0.7 meters below the existing ground surface, according to actual field ground water condition. A single layer of geotextile element is placed at the interface of peat and embankment fill to model the installed wooden mats.

As discussed earlier of this paper, the finite element analyses were performed using effective stress approach. All calculation phases have been computed as fully coupled static/consolidation analysis. Construction sequence and consolidation time of peats and clays were simulated in the model in accordance with actual field conditions. Implementation of the model and simulations of the trial embankment have been completely performed by utilizing PLAXIS 2D (Brinkgreve et al. 2006). **Figure 12** shows the location of finite elements points which were compared to both settlement plates record. Three captured numerical model points were selected to gather better understanding of ground settlement behavior in toe of embankment area. The distance between point A to B and B to C is 1 and 0.5meter, respectively.

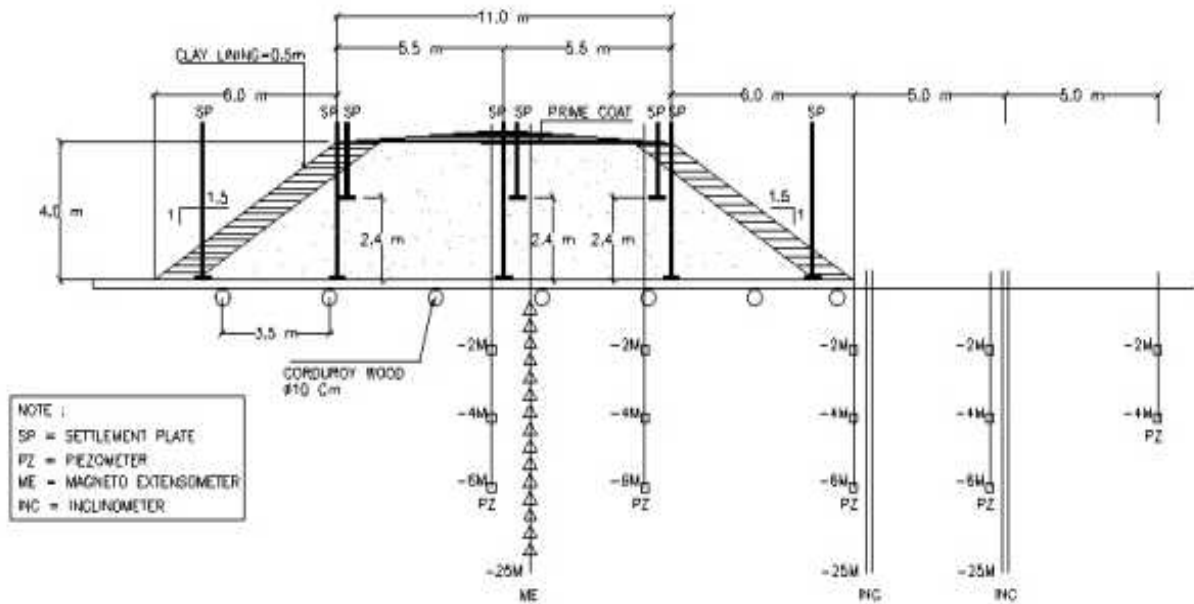

Figure 10. Instrumentation of the trial embankment (Agency of Research and Development, Indonesia Ministry of Public Works, 1998)

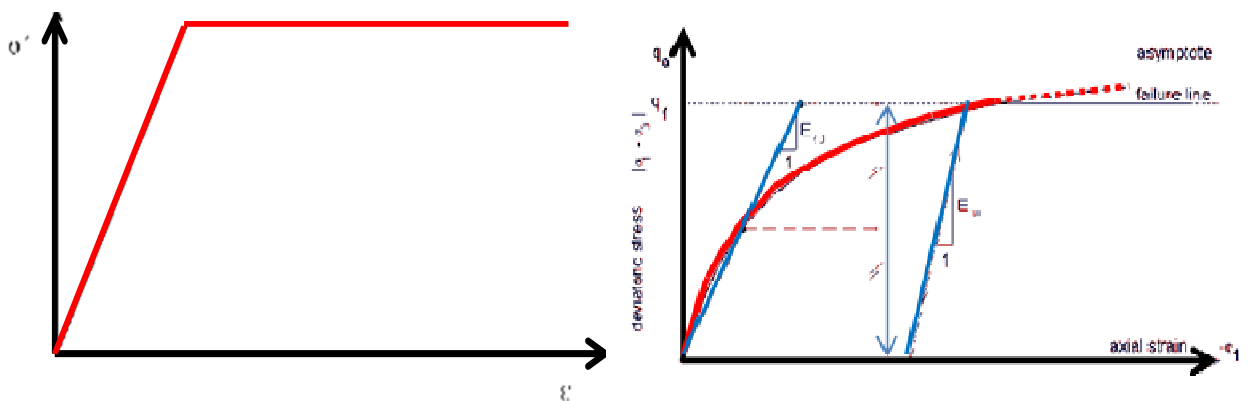

Figure 11. Basic concept of: (a) linear-elastic perfectly-plastic model, and (b) hyperbolic stress-strain relation in primary loading (Brinkgreve et al., 2006)

Table 1. Soil parameters used in finite element models

Parameter	Unit	MC		MC		HS		
		Fill	Peat	Stiff Clay	Soft Clay	Peat	Stiff Clay	Soft Clay
Name		Fill	Peat	Stiff Clay	Soft Clay	Peat	Stiff Clay	Soft Clay
Type		Drained	Drained	Undrained	Undrained	Drained	Undrained	Undrained
γ_{unsat}	(kN/m ³)	19	10	17	16	10	17	16
γ_{sat}	(kN/m ³)	21	12	19	18	12	19	18
K	(m/day]	1	4.5E-3	1.0E-4	1.0E-4	4.5E-3	1.0E-4	1.0E-4
E^{ref}	(kN/m ²)	20000	300	4000	3000	-	-	-
E_{50}^{ref}	(kN/m ²)	-	-	-	-	1200	6000	3000
E_{oed}^{ref}	(kN/m ²)	-	-	-	-	1200	6000	3700
E_{ur}^{ref}	(kN/m ²)	-	-	-	-	3600	18000	9000
c^{ref}	(kN/m ²)	1	1	10	1	1	10	1
ϕ	(°)	32	27	28	15	27	28	15
ψ	(°)	0	0	0	0	0	0	0
V	(-)	0.3	0.3	0.3	0.3	-	-	-
v_{ur}	(-)	-	-	-	-	0.2	0.2	0.2
p^{ref}	(kN/m ²)	-	-	-	-	100	100	100
Power	(-)	-	-	-	-	1	0.8	1
R_f	(-)	-	-	-	-	0.9	0.9	0.9

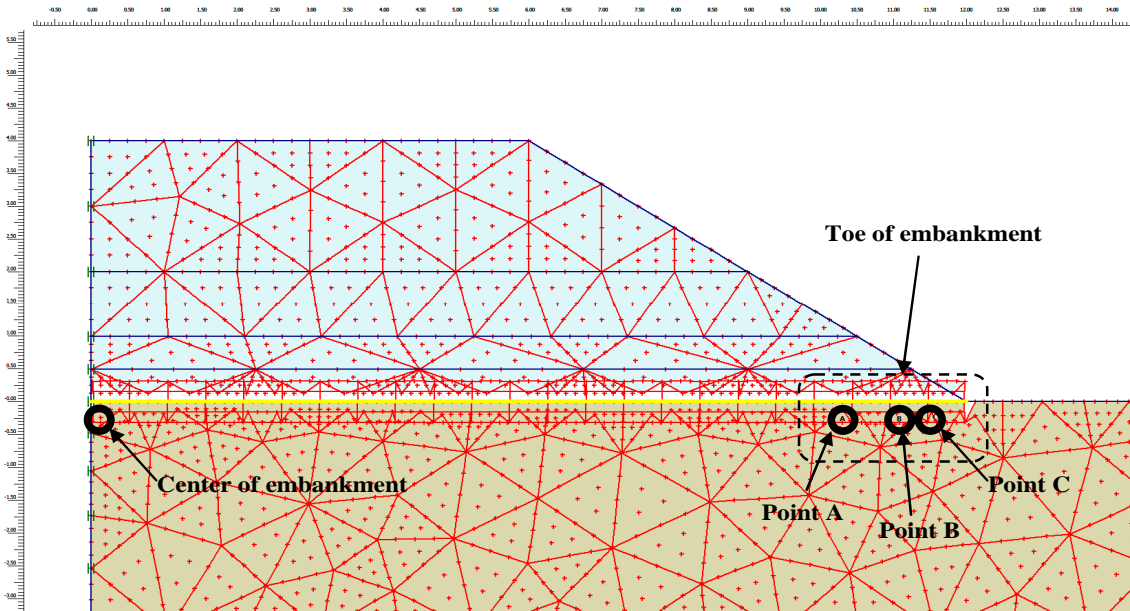

Figure 12. Monitored points of finite element simulations

6. Result and Discussion

6.1 Deformation behaviors by the finite element simulation

Figures 13 and 14 show the deformed mesh and settlement behavior of the finite element models. The figures show that the difference of deformation behavior produced by MC model and HS model is not significant. Both maximum deformations of the embankment body as well as at the supporting soils (peat) just below embankment are relatively the same. The only noticed difference is the deformation spreading. MC model produced wider deformation area than HS model. The reason is due to the HS model's stress-dependency

of stiffness modulus which causes the stiffness of soils increasing as a function of depth. It reduces deformation of deeper layer.

Similar with its deformation behavior, there was also no significant difference in its stability behavior. Both models produced similar slip surface and plastic points which can be seen in Figure 15. Figure 16 shows plastic points as well as plastic regions for both models. Similarly observed by Rowe et al. (1984), considerable plasticity and distortion involving lateral squeeze were observed at base beneath toes. This is most likely caused the discrepancies between numerical simulation and field trial embankment record – will subsequently be discussed further.

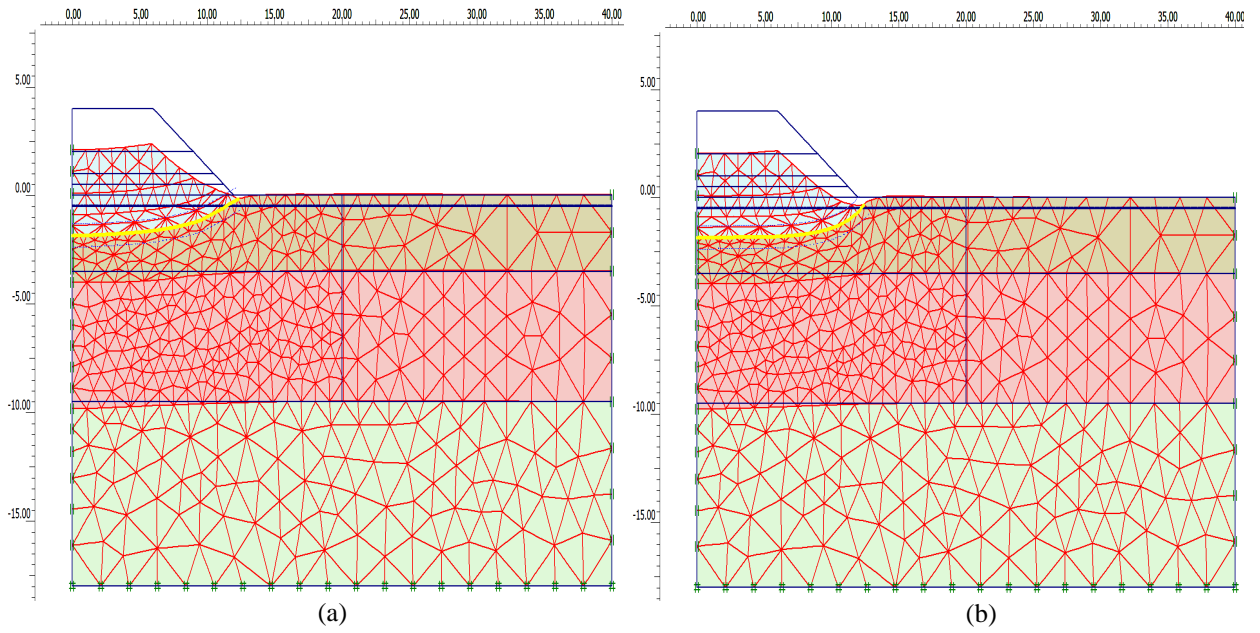

Figure 13. Deformed mesh: (a) MC model and (b) HS model

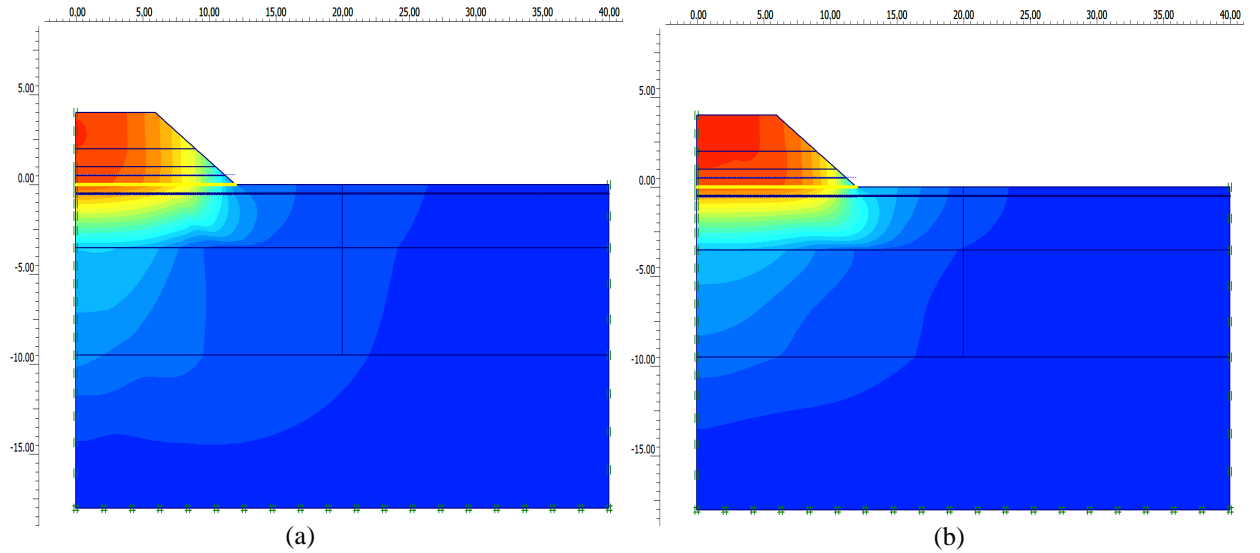

Figure 14. Deformation contours: (a) MC model, and (b) HS model

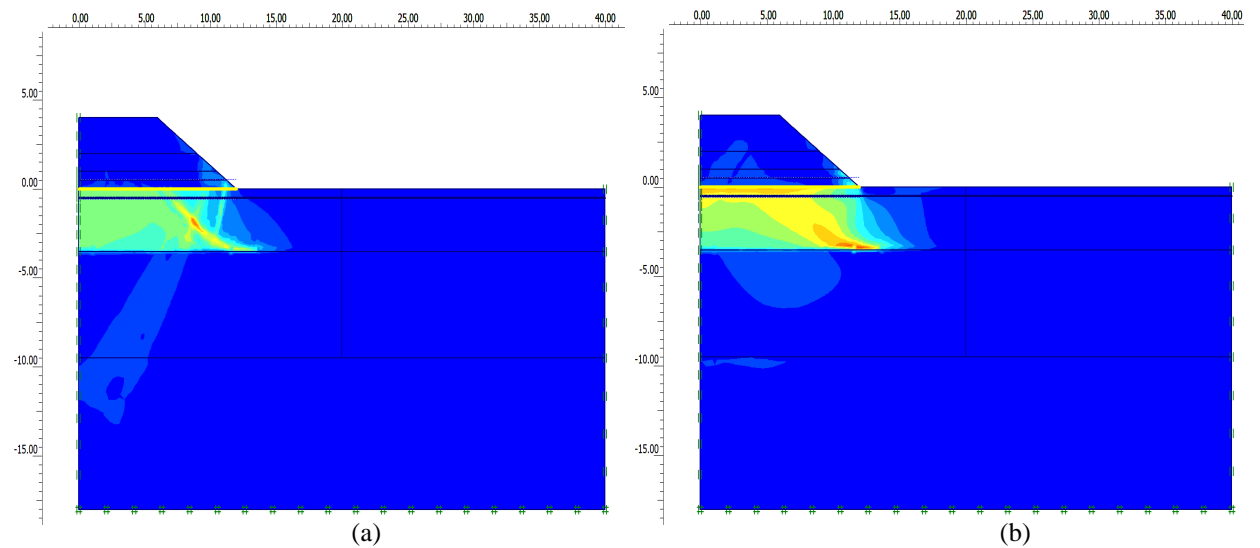

Figure 15. Total strain/slip surface: (a) MC model and (b) HS model

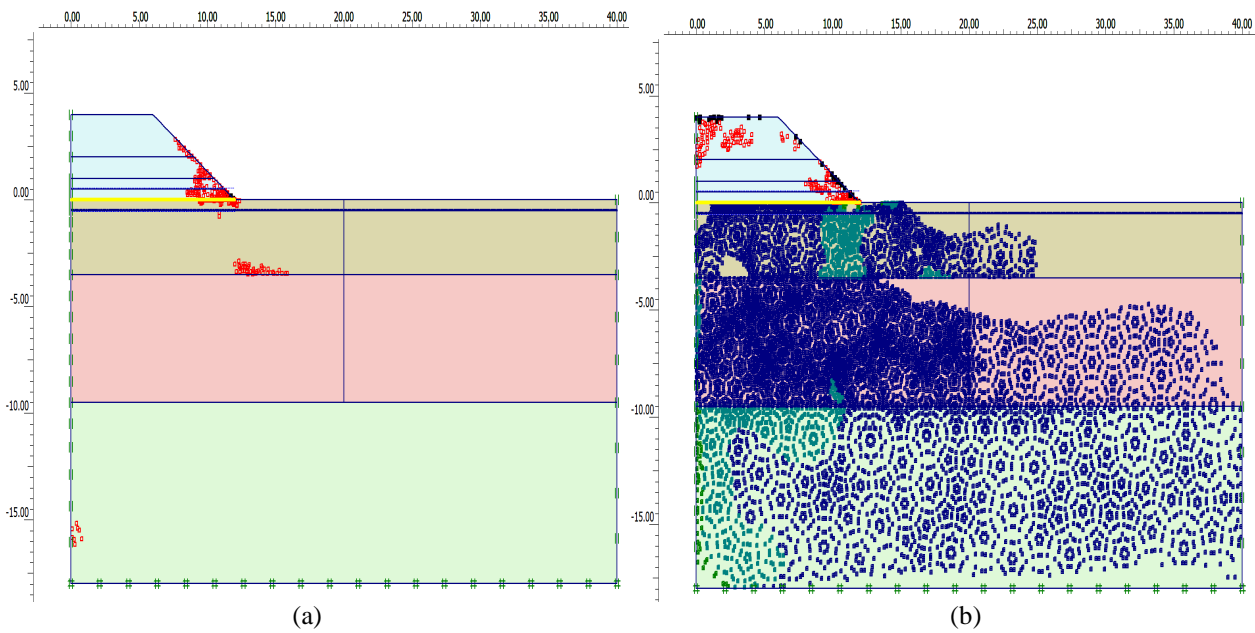

Figure 16. Plastic points: (a) MC model and (b) HS model

6.2 Settlement at base of embankment - finite element simulation vs. field records

Results of the finite element simulations were next verified by full scale field test measurement records of the trial embankment. **Figure 17** shows the ground settlement behavior at the center of embankment base. The field recorded settlement behavior was gathered based on SP-8 measurements. The figure shows that both soil constitutive models (MC model and HS model) were able to produce final vertical deformations fairly similar to the measurement field data. In this study, the MC and HS models only produced percentage of discrepancies less than 10% and 5%, respectively. Further, as discussed earlier, the more complex soil constitutive model, HS model produce better deformation behavior curve than the simpler MC model. As shows in **Figure 17**, HS model produces nearly identical settlement behaviors with recorded field settlement especially from day 25 to the end of observation time. There are some discrepancies found in numerical simulation results, particularly in early stages of embankment construction. At the early construction stages, both models overestimated the settlement magnitude. The potential cause of the discrepancy at the early stages of construction is the influences of the wooden mats to the embankment settlement behavior and the method of filling and stages of filling in smaller increment time.

However, at toes of embankment, at observation points, deformations from finite element results and the monitored data from SP-10 measurements are not as close as they are at the center of embankment. Both soil constitutive models could not produce reasonably-fit curves to its actual settlement curve. **Figure 18** shows the

result of these captured points by finite element simulation as well as their field monitored deformation behavior. Based on these results, it is known that at this area, even small distance between reviewed points could produce different result. The best fit curves for both models are Points B and C, however these still have more than 15% discrepancies. Again, the most discrepancies were at early stages of embankment construction sequence. Beside consideration of wooden mats influence and/or yield points (local failures) issues are predicted to be the major cause of discrepancies at this area. The heave behavior at Point C for both models supports the conclusion. Both models were still not excellent in predicting complete behaviors at embankment toes.

The result of this study shows that both soil constitutive models can produce reasonably suitable ground settlements behavior of embankment on peat. However, lateral deformation and stability issues should be taken into consideration since it affects the general deformation behavior. Even though still can be improved, the input parameters used which is based on field and laboratory tests and available correlation are sufficient to produce several basic behaviors appropriately, especially at center of embankment.

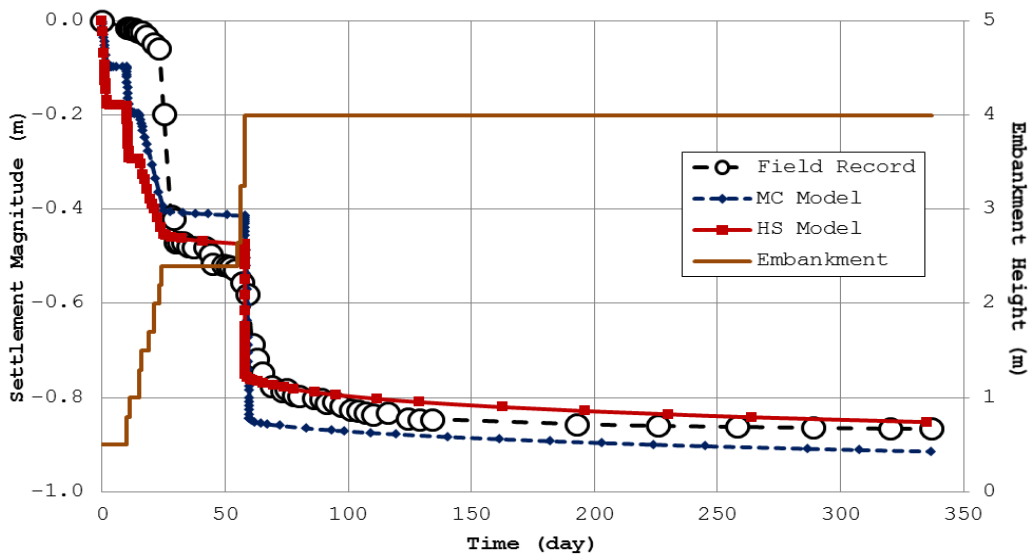
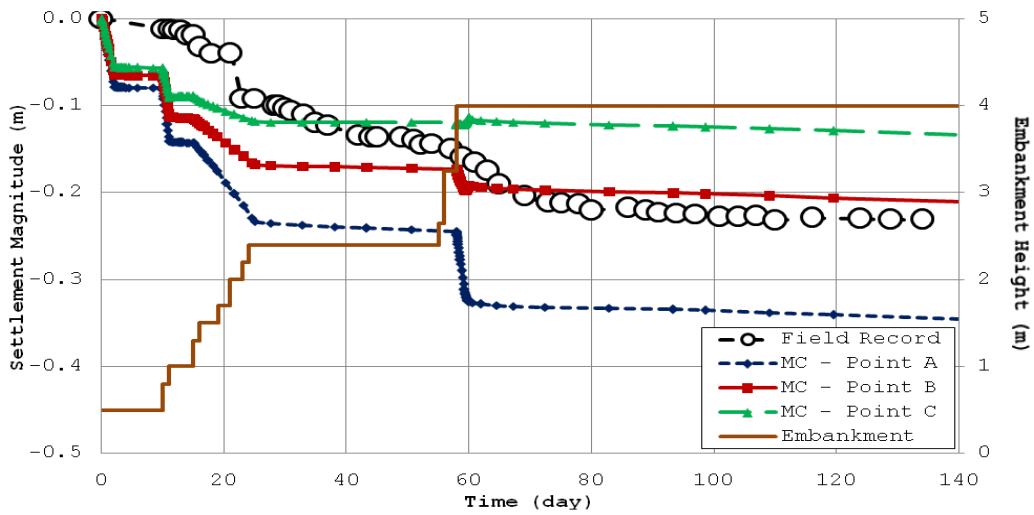
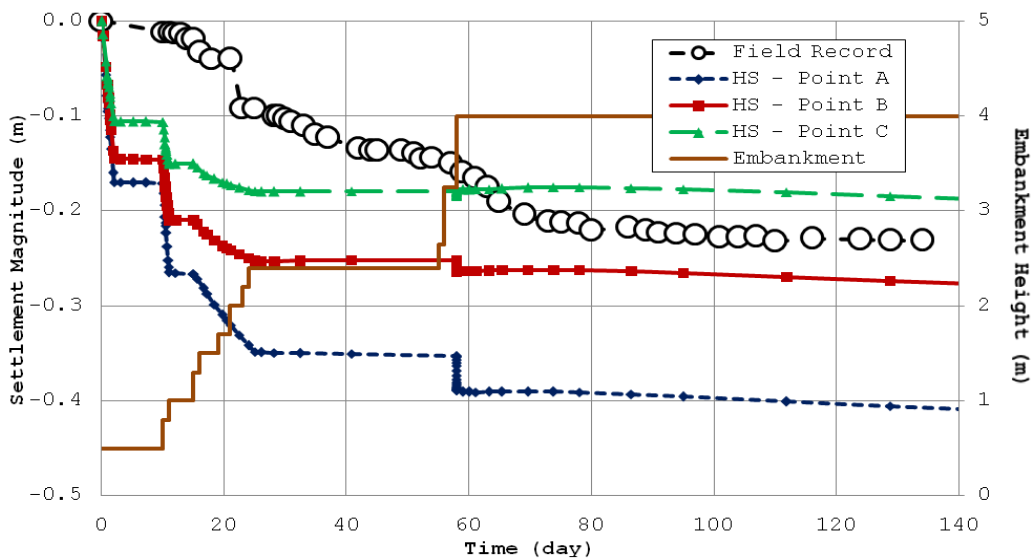

Figure 17. Settlement behavior of foundation soils at the center of the embankment



(a)



(b)

Figure 18. Settlement behavior of foundation soils at toes of the embankment: (a) MC model and (b) HS model

7. Conclusion

Site investigation, construction, instrumentation and monitoring of a trial embankment on very compressible fibrous tropical peat layer at Bereng Bengkel in Central Kalimantan Province have been conducted by Agency of Research and Development, Ministry of Public Works. Settlement responses of this trial embankment have been investigated by series of finite element simulations using two different soil constitutive models: elastic perfectly plastic with the Mohr-Coulomb criteria and Hardening-Soil models. Based on analysis results, we can conclude the followings:

1. The ground exploration found a substantial organic soil deposit of peat from the ground surface to approximately 3.5 meters below ground surface. This type of Bereng Bengkel peat varied ranging from a fibrous peat with fiber content at about 38.1% to predominantly amorphous peat with fiber content at about 19.5%. The average moisture content of this layer was 940% while the average value of initial void ratio (e_0), coefficient of compressibility (c_c) and coefficient of recompression (c_r) were 12.11, 5.20 and 0.26, respectively.
2. Interpretation of CPT results gives average undrained shear strength value of this peat layer was at about 9 kPa, while further tests interpretation concludes its effective strength envelope with $c' = 1$ kPa and $\phi' = 27^\circ$. For its stiffness modulus, a correlation of $E = 30S_u$ layer under low pressure condition (about 10 to 30 kPa) appears appropriate for this peat. By using reference pressure of 100 kPa, the correlation of peat stiffness modulus will be adjusted to $E_{50}^{ref} = 120S_u$.
3. Even though still can be improved, the input parameters used which is based on field and laboratory tests, and available correlation seems sufficient to produce basic behaviors correctly, especially in the area which only encounter vertical direction deformation, in this study at the center of embankment.
4. It can be concluded that the difference between deformation behavior produced by MC model and HS model is not significant. One of the differences can be found is most likely in the deformation spreading.
5. For ground settlement behavior at center of embankment, the result of this study shows that both of the soil constitutive models can produce reasonably suitable deformation behavior. In this study, MC and HS models only produced percentages of differences of less than 10% and less than 5%, respectively.
6. There are some discrepancies found in early stage of embankment construction sequence. Both soil constitutive models overestimated the settlement magnitude at early construction stages. The potential cause of the discrepancy at the early stages of construction is the influences of the wooden mats to the embankment settlement behavior and the method of filling and stages of filling in smaller increment time.
7. For ground settlement behavior at toes of embankment, settlement behaviors predicted by both MC and HS models are still not as accurate as at center compared to recorded field data. The best fit curves at toe of embankment for both numerical models are Point B and C; still these have more than 15% discrepancies encountered. The effect of wooden mats, including local mechanism and/or yield points (local failures) issues are predicted to be the major cause of discrepancies at the points.

A study of stability prediction and behaviors of lateral displacement of embankment on peat could be performed for further research.

8. Acknowledgements

The site investigation, construction, instrumentation and monitoring of the trial embankment were coordinated and conducted by Agency of Research and Development, Ministry of Public Works of Indonesia. The authors also wish to acknowledge the Institute of Road Engineering as a one of the research center under Agency of Research and Development for providing these data and record.

References

- Apoji, D., Susila, E., 2012, Couple Behaviors of Clays: Laboratory Test and Numerical Simulations. *Proceedings of the 16th Annual Scientific Meeting, HATTI (ISGE)*, (pp. 227-233). Jakarta.
- Bell, F.G., 2000, *Engineering properties of soils and rocks, 4th Ed. Oxford*, London: Blackwell Science.
- Berry, P.L., Vickers, B., 1975, Consolidation of Fibrous Peat, *Journal of Geotechnical Engineering, ASCE*, 101: 741-753.
- Bowles, J.E., 1996, *Foundation Analysis and Design, 5th Ed.* The McGraw-Hill Companies, Inc.
- Brinkgreve, R.B., Broere, W., and Waterman, D., 2006, *Manual PLAXIS 2D - Version 8.* Delft, Netherlands: PLAXIS bv.

- Colleselli, F., Cortellazzo, G., and Cola, S., 2000, Laboratory Testing of Italian Peat Soils. In Edil, T.B. and Fox, P.J., *Geotechnics of High Water Content Materials, ASTM STP 1374*. West Conshohocken, PA: American Society for Testing and Materials.
- Das, B.M., 2002, *Principles of Geotechnical Engineering*. Pacific Grove, CA: Brooks Cole/Thompson Learning.
- Dhowian, A.W., Edil, T.B., 1980, Consolidation Behavior of Peats. *Geotechnical Testing Journal*, 105-114.
- Edil, T.B., 2003, Recent Advances in Geotechnical Characterization and Construction Over Peats and Organic Soils. Malaysia: *Proceedings of the 2nd International Conference in Soft Soil Engineering and Technology*, Putrajaya.
- Ferrel, E.R., Hebbib, S., 1998, The Determination of The Geotechnical Parameters of Organic Soils. Japan: *Proceedings of International Symposium on Problematic Soils, IS-TOHOKU*, (pp. 33-36). Sendai.
- Final Report IGMC Guide Phase 1, 1998, Bandung: Agency of Research and Development Ministry of Public Works Indonesia.
- Fox, P.J. and Edil, T.B., 1996, Effects of Stress and Temperature on Secondary Compression of Peat, *Canadian Geotechnical Journal*, 33: 405-415.
- GeoGuide, 2002, Jakarta: Ministry of Settlement and Regional Infrastructure.
- Gofar, N., Sutejo, Y., 2007, Long Term Compression Behavior of Fibrous Peat, *Malaysian Journal of Civil Engineering*, 19: 104-116.
- Gosling, D., Keeton, P., 2008, Problems with Testing Peat for Stability Analysis. *Peat Seminar*. Edinburg.
- Hatlen, J., Wolski, J., 1996, *Embankments on Organic Soils, 1st Ed.* USA: Elsevier.
- Huat, B.B., Asadi, A., and Kazemian, S., 2009, Experimental Investigation on Geomechanical Properties of Tropical Organic Soils and Peat, *American Journal of Engineering and Applied Science*, 184-188.
- Karlsson, R., Hansbo, S., 1981, *Soil Classification and Identification, 1st Ed.* Stockholm: Swedish Council for Building Research.
- Keene, P., Zawodniak, C.D., 1968, Embankment Construction on Peat Utilizing Hydraulic Fill, Singapore: *Proceedings of the 11th Southeast Asian Geotechnical Conference*, (pp. 45-50)..
- Kogure, K., Yamaguchi, H., and Shogaki, T., 1993, Physical and Pore Properties of Fibrous Peat Deposit. Singapore: *Proceedings of the 1th Southeast Asian Geotechnical Conference*.
- Kulhawy, F.H., Mayne, P.H., 1990, *Manual on Estimating Soil Properties for Foundation Design, Report EL-6800 Electric Power Research Institute*. EPRI.
- Kuthilaka, S.A., 1999, Improvement of Engineering Properties of Peat by Preconsolidation, South Korea: *Proceedings of the Asian Regional Conference of Soil Mechanics and Geotechnical Engineering*, (pp. 97-100).
- Landva A.O. and Pheeneey, P.E., 1980, *Peat Fabric and Structure*, *Geotechnique*, 17:416-435.
- Lea, N.D., Brawner, C.O., 1963, Highway Design and Construction Over Peat Deposits in Lower British Columbia, *Highway Res. Record*, 7: 1-32.
- Lefebvre, G., Langlois, P., Lupien, C., and Lavallee, J. G., 1984, Laboratory Testing and in Situ Behaviour of Peat as Embankment Foundation, *Canadian Geotechnical Journal*, 21: 322-337.
- McGeever, J., 1987, *The Strength Parameters of an Organic Silt, MSc Thesis*. University of Dublin, Trinity College.
- Progress Report IGMC Guide Phase 2, 2001, Bandung: Agency of Research and Development, Ministry of Public Works Indonesia.
- Rowe, R.K., MacLean, M.D., and Barsvary, A.K., 1984a, The Observed Behaviour of A Geotextile-Reinforced Embankment Constructed on peat. *Canadian Geotechnical Journal*, 21: 289-304.
- Rowe, R.K., MacLean, M.D., and Soderman, K.L., 1984b, Analysis of A Geotextile-Reinforced Embankment Constructed on Peat, *Canadian Geotechnical Journal*, 21: 563-576.
- Schanz, T., and Vermeer, P.A., 1998, Special Issue on Pre-Failure Deformation Behaviour of Geomaterials. *Geotechnique*, 48, 383-387.
- Schanz, T., Vermeer, P.A., and Bonnier, P.G., 1999, The Hardening-Soil Model: Formulation and Verification, In Brinkgreve, R.B., *Beyond 2000 in Computational Geotechnics* (pp. 281-290), Rotterdam: Balkema.

- Siavoshnia, M., Kalantari, F., and Shakiba, A., 2010, Assesment of Geotextile Reinforced Embankment on Soft Clay Soil, *Proceedings of The 1st International Applied Geological Congress, Department of Geology, Islamic Azad University*, (pp. 1779-1784), Mashad Branch, Iran.
- Termaat, R. J., 1994, General Report: Session 2: Stress-Strain and Strength Behaviour, In Al, D.H., *Advance in The Understanding and Modeling The Mechanical Behaviour of Peat* (pp. 311-326), Rotterdam: Balkema.
- Terzaghi, K., Peck, R.B., and Mesri, G., 1996, *Soil Mechanics in Engineering Practice, 3rd Ed.* New York: Wiley & Sons.
- Warburton, J., Holden, J., and Mills, A.J., 2004, Hydrological Controls of Surficial Mass Movements in Peat, *Earth Science Review*, 139-156.
- Weber, W.G., 1969, Performance of Embankments Constructed Over Peat, *Journal of Soil Mech. Found. Div.*, 53-76.
- Wong, L.S., Hashim, R., and Ali, F.H., 2009, A Review on Hydraulic Conductivity and Compressibility of Peat, *Journal of Applied Sciences*, 9 (18): 3207-3218.